



# 600'54 Ascend Aeon

- User Manual

Version 03



Copyright © by Bruker Corporation

All rights reserved. No part of this publication may be reproduced, stored in a retrieval system, or transmitted, in any form, or by any means without the prior consent of the publisher. Product names used are trademarks or registered trademarks of their respective holders.

This manual was written by

Renate Petry

© September 22, 2015: Bruker Corporation

Faellanden, Switzerland

ZTKS0240 / Z31963 / 03

For further technical assistance on the NMR Magnet System, please do not hesitate to contact your nearest BRUKER dealer or contact us directly at:

BRUKER BioSpin AG  
Industriestrasse 26  
CH-8117 Faellanden  
Switzerland

Phone: + 41 44 825 91 11  
FAX: + 41 44 825 96 96  
E-mail: [magnetics@bruker.ch](mailto:magnetics@bruker.ch)  
Internet: [www.bruker.com](http://www.bruker.com)

---

<b>Contact .....</b>	<b>7</b>
<b>1 Introduction.....</b>	<b>9</b>
1.1 General Information.....	9
1.2 Limitation of Liability.....	9
1.3 Customer Service.....	9
1.4 Warranty.....	9
1.5 Copyright.....	9
1.6 General View.....	10
<b>2 Safety.....</b>	<b>13</b>
2.1 Approved Persons.....	13
2.2 Customer Responsibilities.....	14
2.3 Key Words.....	15
2.4 Residual Risks.....	16
2.4.1 Persons.....	16
2.4.2 Intended Use.....	16
2.4.3 Safety Devices.....	17
2.4.4 Spare Parts.....	17
2.4.5 Signs and Labels.....	18
2.4.6 Technical Risks.....	18
2.5 Personal Protective Equipment.....	25
2.6 Description of Signs and Labels.....	26
2.7 Safety Devices.....	27
2.8 Behavior in Danger and Emergency Situations.....	28
2.9 Fire Department Notification.....	28
<b>3 Transportation.....</b>	<b>29</b>
3.1 Safety.....	29
3.2 Packaging.....	29
3.2.1 Disposal.....	30
3.3 Transport Inspection.....	30
3.4 Transportation by Fork Lift / Pallet Jack.....	31
3.5 Transportation with a Crane.....	32
3.6 Storing.....	33
3.7 Disposal.....	33
<b>4 Assembling.....</b>	<b>35</b>
4.1 Safety.....	35
<b>5 Operation.....</b>	<b>37</b>
5.1 Safety.....	37

5.2	Set into Operation.....	38
<b>6</b>	<b>Troubleshooting .....</b>	<b>39</b>
6.1	Safety .....	39
6.2	Problem .....	40
6.2.1	During Transportation.....	40
6.2.2	During Assembling .....	40
6.2.3	During Cool Down .....	42
6.2.4	During Energizing and Shimming.....	46
6.2.5	During Operation of the Magnet Stand.....	48
6.2.6	During Standard Operation.....	50
6.2.7	During De-energizing and Warming up .....	70
6.2.8	During Operation of the Cryogenic Refrigerator .....	71
6.3	Troubleshooting Work .....	76
6.3.1	After a Quench .....	76
6.3.2	Procedure in case of an alarm signal .....	77
6.3.3	Procedure in case of Cryogenic Refrigerator failure.....	78
<b>7</b>	<b>Maintenance.....</b>	<b>79</b>
7.1	Safety .....	79
7.2	Cleaning .....	80
7.3	Maintenance Timetable .....	80
7.4	Maintenance Work at the Cryogenic Refrigerator .....	82
<b>8</b>	<b>Disassembling .....</b>	<b>83</b>
8.1	Safety .....	83
<b>9</b>	<b>Technical Data MS 600'54 Ascend Aeon RZ.....</b>	<b>85</b>
9.1	Environmental Conditions.....	85
9.2	Identification Plate .....	85
9.3	Dimensions.....	86
9.3.1	Weights.....	86
9.3.2	Dimensions for Transportation .....	86
9.3.3	Dimensions Cryostat .....	87
9.4	Filling Volume, Evaporation Rate and Hold Time.....	90
9.5	Helium Level Graph.....	91
9.6	Helium Level Sensor .....	92
9.7	Temperature Sensors.....	93
9.8	Technical Data Magnet.....	96
9.9	Fringe Field Plot .....	97
9.10	Technical Data Cryogenic Refrigerator .....	98
9.11	Current Lead.....	100

9.11.1	Wiring Diagram Magnet.....	101
9.11.2	Wiring Diagram Magnet Control .....	102
9.11.3	Wiring Diagram Magnet Diagnostic and Temperature Sensors .....	103
9.11.4	Shorting Plug .....	104
9.12	Resistance at Room Temperature .....	105
9.13	Heater Currents.....	106
9.14	Shim Switch Heater.....	106
9.15	Energizing Assignment and Currents.....	107
9.16	Magnetic Center .....	108
9.17	Cycling Assignment and Shim Currents.....	109
9.18	Energizing Currents.....	110
9.19	Deenergizing Assignment and Currents.....	110
9.20	Magnet System Report.....	111
 <b>Appendix A .....</b>		 <b>113</b>
A.1	Warning Signs .....	113
A.2	Figures .....	115
A.3	Tables.....	117
A.4	Glossary / Abbreviations .....	119
A.5	Index.....	121



# Contact

## **Manufacturer**

Bruker BioSpin AG

Industriestrasse 26

CH-8117 Faellanden

Switzerland

Phone: + 41 44 825 91 11

Fax: + 41 44 825 96 96

<http://www.bruker.com>

E-mail: [2nd-level-support.bbio@bruker.com](mailto:2nd-level-support.bbio@bruker.com)

Please refer to the Model No., Serial No. and Internal Order No. in all correspondence regarding the NMR system or components thereof.





# 1 Introduction

## 1.1 General Information

---

This manual contains important information about the handling of the supplied magnet system used for NMR spectroscopy and its components. The compliance with all safety and handling instructions, the applicable local accident prevention and general safety regulations are necessary for safe work.

This manual is part of the product. It must be kept nearby the magnet system and free access must be ensured at any time. Read the manual carefully before handling the magnet system or its components.

## 1.2 Limitation of Liability

---

The information in this manual will take into account the current state of the technology.

The manufacturer assumes no liability for damages resulting from:

- non-compliance with the instructions and all applicable documentation,
- use for purposes not intended,
- not sufficiently approved persons,
- arbitrary changes or modifications and
- use of not approved spare parts or accessories.

## 1.3 Customer Service

---

Technical support is provided by Bruker Service via telephone or e-mail. For contact information [see page 7](#) of this document.

## 1.4 Warranty

---

The warranty terms can be found in the sales documents of the magnet system and in the Terms and Conditions of Bruker BioSpin AG.

## 1.5 Copyright

---

No part of this publication may be reproduced, stored in a retrieval system, or transmitted, in any form or by any means without the prior consent of the publisher. Product names used are trademarks or registered trademarks of their respective holders.

## 1.6 General View

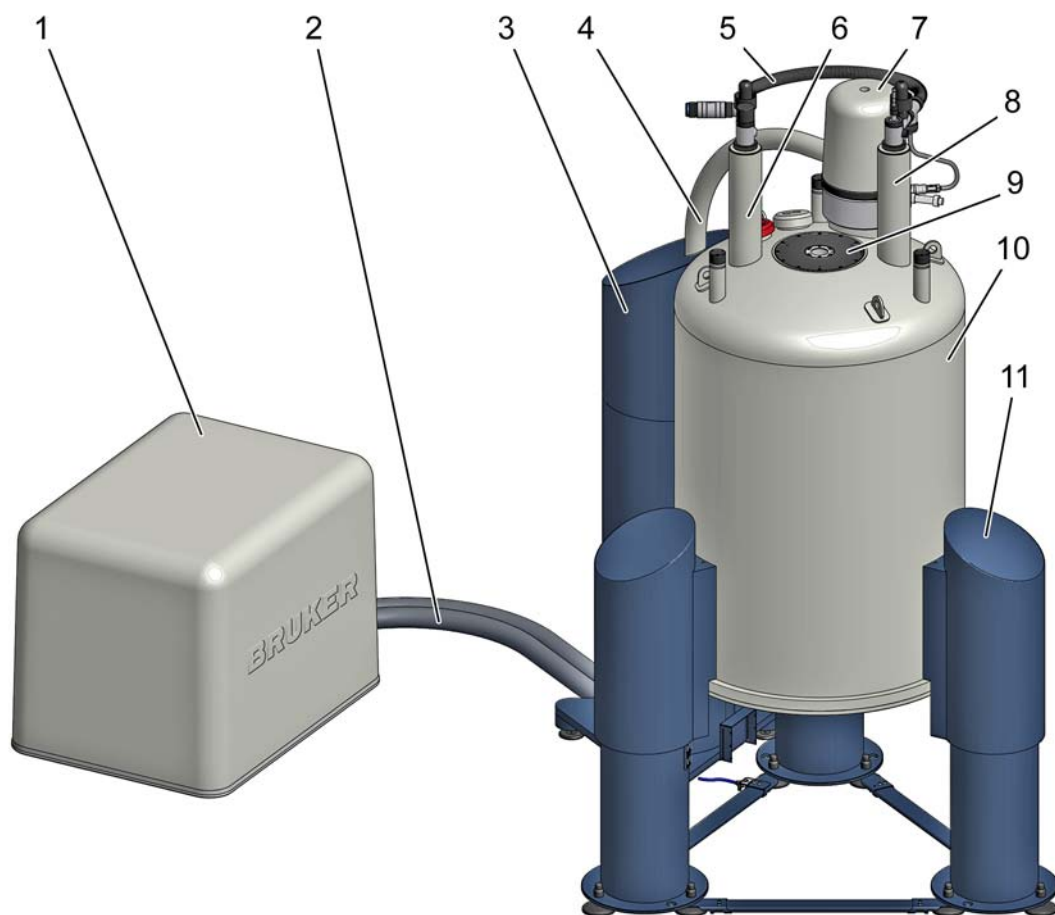

- |  |  |
|--|--|
| 1 Cryogenic Refrigerator Compressor                          | 7 Cryogenic Refrigerator Cold Head               |
| 2 Cryogenic refrigerator flex lines                          | 8 Helium fill-in turret with helium fill-in port |
| 3 Rotary Valve (RV) covered by the Rotary Valve Column (RVC) | 9 Room temperature bore                          |
| 4 Connecting Line  | 10 Room temperature vessel                       |
| 5 Helium flow system   | 11 Magnet Stand                                  |
| 6 Current lead turret  |  |

Figure 1.1: General view of the Magnet System Ascend Aeon

The heart of the NMR magnet system is a superconducting magnet located inside the helium vessel, which is filled with liquid helium. The helium vessel is surrounded by a radiation shield (RS), which is cooled by a Cryogenic Refrigerator. The outer casing, the room temperature (RT) vessel (10) contains the helium vessel and the radiation shield. The vacuum inside the RT vessel reduces thermal conduction. The RT bore (9) allows the access to the magnetic center. RT vessel, helium vessel, radiation shield, helium turrets, flow system and the RT bore together build the cryostat of the magnet system.

The cryostat is mounted on a magnet stand (11). The isolators in the magnet stand absorb floor vibrations. Different heights and isolators are available optionally.

The helium turrets (6, 8) connected with the helium flow system (5) are the interface of the helium vessel and the magnet coil. The helium fill-in turret (8) is marked with a yellow label. The current lead turret (6) is the interface for energizing the magnet coil and for diagnostic.

The Cryogenic Refrigerator is a closed loop helium expansion cycle. It consists of a Compressor (1), two Flex Lines (2), a remote Rotary Valve inside the Rotary Valve Column (3), a Cold Head (7) and a Connecting Line (4) between Rotary Valve and Cold Head. The Rotary Valve, Flex Lines, Connecting Line and Cold Head are covered by noise protection.

Depending on the customers site restrictions several options of the Cryogenic Refrigerator are possible. Refer to the order subscription and to the supplied manuals of the supplied equipment.



## 2 Safety

The supplied cryostat and further equipment of the magnet system were designed and manufactured according to best available technical knowledge and practice, achieved in over 50 years of experience of Bruker Corporation. International standards for quality and approval recommended for cryostats of superconducting magnets were certified.

Nevertheless non-compliance with the following instructions and safety advice may cause serious hazards and property damage.

### 2.1 Approved Persons

---

Bruker BioSpin AG identifies the following qualifications for personnel performing tasks on the magnet system or its components:

#### **Approved Customer Personnel**

As a result of professional training by Bruker Service Personnel, experience and knowledge of applicable regulations these persons are qualified to perform the specific tasks on the magnet system and its components assigned to them in this manual. Approved Customer Personnel are qualified to identify possible hazards and risks associated with the tasks assigned to them and to perform all possible steps to eliminate or minimize these risks.

#### **Bruker Service Personnel**

These persons are qualified by appropriate qualification and professional training and experience (including all necessary knowledge of applicable regulations and regulatory requirements) to perform specific tasks on the magnet system and its components. Bruker Service Personnel are qualified to identify possible hazards and risks and to perform all possible steps to eliminate or minimize these risks.

## 2.2 Customer Responsibilities

---

The customer must obey the security advice and the rules for safety, applicable local accident prevention and environmental protection correctly for the magnet system. Furthermore, the customer is responsible for keeping the magnet system in good technical condition.

### In particular:

- The customer must identify additional dangers resulting from the working conditions at the site of the magnet system and provide applicable safety measures.
- The customer must ensure that the site plan meets the specified conditions according to the site planning document for operating the magnet system.
- The customer must clearly mark the danger area around the magnet system and post the corresponding instruction plates.
- The customer has to ensure the intended use of the magnet system.
- The customer has to inform the local fire brigade about the special risks of the magnet system and how to react in the event of an incident.
- The customer must clearly define the responsibilities for operation and maintenance.
- The customer must ensure that all employees working with the magnet system have read and understood the manual.
- The customer has to provide the necessary personal protective equipment for his employees.
- The customer has to instruct his employees at regular intervals on hazards and safety measures.
- The customer has to instruct other persons not working on the magnet system but carrying out work in the same room, for instance cleaning staff or guards about the possible danger at the site of the magnet system.
- The customer has to consider the specific items of this cryostat equipped with a Cryogenic Refrigerator. The customer is responsible for obeying the advice given in this manual. In case the Cryogenic Refrigerator is not running correctly his immediate reaction is mandatory. In case of an unexpected alarm his immediate response is mandatory. For further instruction refer to chapter "[Troubleshooting](#)" on [page 39](#).
- The customer must ensure that maintenance is performed according to the schedule listed in chapter "[Maintenance Timetable](#)" on [page 80](#).

## 2.3 Key Words

---

Safety instructions in this manual are marked with symbols. The safety instructions are introduced using indicative words which express the extent of the hazard.

In order to avoid accidents, personal injury or damage to property, always observe safety instructions and proceed with care.



### **! DANGER**

This combination of symbol and signal word indicates an immediately hazardous situation which could result in death or serious injury unless avoided.



### **! WARNING**

This combination of symbol and signal word indicates a potentially hazardous situation which could result in death or serious injury unless avoided.



### **! CAUTION**

This combination of symbol and signal word indicates a possibly hazardous situation which could result in minor or slight injury unless avoided.

### **SAFETY INSTRUCTIONS**

This combination of color and signal words are used for control flow and shutdowns in the event of an error or emergency.

### **NOTICE**

This combination of color and signal word indicates a possibly hazardous situation which could result in damage to property or the environment unless avoided.



This symbol highlights useful tips and recommendations as well as information designed to ensure efficient and smooth operation.

---

## 2.4 Residual Risks

---

In the following chapter the residual risks from the risk analysis according ISO 14971 are summarized. To prevent health hazards and hazardous situations obey all safety instructions and warnings in the manual.

### 2.4.1 Persons

---

#### **WARNING**



#### **Risk of injury and property damage due to handling of not approved persons.**

Incorrect handling of the magnet system by not approved persons may result in significant bodily injury and property damage.

Thus:

- Work must only be carried out by approved persons with applicable qualifications. The necessary qualifications are specified in the beginning of the relevant chapter.
- In case of doubt, contact Bruker Service. For contact information [see page 7](#) of this document.

### 2.4.2 Intended Use

---

The supplied magnet systems is designed and intended for NMR spectroscopy only.

#### **WARNING**



#### **Risk of damage to life and limb by incorrect use of the magnet system.**

Incorrect use of the magnet system can lead to life-threatening situations and destruction of the magnet system.

Thus:

- Only use the magnet system as intended.
- Do not change the magnet system.
- Do not exceed specified values for operating the magnet system.
- Do not use inserts inside the RT bore not approved by Bruker Service.

Damage claims from damages caused by other than the intended use of the magnet system are excluded and the customer is held liable.



### 2.4.3 Safety Devices

---

#### WARNING



##### **Risk of damage to life and limb due to not sufficient safety devices.**

Several safety devices ensure safe operation of the magnet system. They must always be in correct working condition.

Thus:

- Do not block safety devices.
- Do not remove safety devices.
- Check the operational reliability of the safety devices before working on the magnet system.

### 2.4.4 Spare Parts

---

#### WARNING



##### **Risk of injury and property damage from using incorrect or defective spare parts and accessories.**

Incorrect or defective spare parts can cause serious injuries. They may cause damaging, malfunctioning and the destruction of the magnet system.

Thus:

- Only use original equipment manufacturer spare parts.
- Only use original equipment manufacturer accessories.

## 2.4.5 Signs and Labels



### **WARNING**

#### **Risk of damage to persons and property due to not readable signs and labels.**

Signs and labels with advice may become not readable.

Thus:

- Maintain signs and labels in a readable state.
- Replace damaged or not readable signs and labels immediately. New signs and labels can be ordered from Bruker Service.

## 2.4.6 Technical Risks

### Magnetic Field



### **WARNING**

#### **Risk of damage to life and limb due to high magnetic fields.**

A magnetic field of more than 0.5 mT (5 Gauss) is life-threatening for people with pacemakers or active metal implants. Exposure to more than 8 T can cause damage to health. Duration of exposure (8 h/day) above the limit of 200 mT can cause damage to health. Ferromagnetic tools in the magnetic field are significantly hazardous. Disks and electronic devices may be damaged.

Thus:

- Mark the magnetic field of more than 0.5 mT (5 Gauss) before start up.
- Keep people with active medical implants away from the 0.5 mT (5 Gauss) area.
- The permanent workplace of employees must be outside the 0.5 mT (5 Gauss) area.
- Do not stay or work at magnetic fields of more than 8 T.
- Prevent exposure of more than 200 mT for more than 8 h/day.
- Keep disks, credit cards and electronic devices away from the identified area.
- Do not use ferromagnetic tools or items within the identified area.
- Only use non-ferromagnetic transportation dewars or pressure cylinders for the cryogenic agents.
- Only use non-ferromagnetic ladders or steps.

## Cryogenic Agents

### WARNING

#### **Risk of damage to life and limb due to cryogenic agents.**

Risk of damage to life and limb due to not correct handling of liquid cryogenic agents. Within the transition from liquid to gas, helium and nitrogen expand their volume, causing closed vessels or transportation dewars to burst. The evaporating cryogenic agents will displace the breathing air. Helium displaces the breathing air in the upper part of the room, nitrogen displaces the breathing air in the lower part of the room. In case of not sufficient ventilation this may result in death by suffocation.

Liquid and gaseous cryogenic agents are extremely cold. Contact with liquid or gaseous cryogenic agents will lead to cold burns. Contact with the eyes may cause blindness. Refer to Warning: Low Temperature.

Thus:

- Only use cryogenic agents in well ventilated rooms. In case of doubt ask Bruker Service.
- Wear an oxygen monitor on the body during service and maintenance work.
- Prevent any skin contact with liquid or gaseous cryogenic agents.



## Low Temperatures

### WARNING

#### **Risk of injury due to low temperatures of liquids and metal parts.**

Physical contact with extremely cold liquids and metal parts may cause serious injuries. Contact with the skin may cause cold burns. Contact with the eyes may cause blindness.

Thus:

- Always wear protective goggles, protective gloves and protective clothes while handling with liquid cryogenic agents or metal parts in contact with liquid cryogenic agents.
- Protect temperature sensitive components such as O-rings from contact with liquid cryogenic agents.



## Electricity



### **WARNING**

#### **Risk of damage to life and limb due to electricity.**

Risk of damage to life and limb due to contact with electrical lines and damaged insulation.

Thus:

- Work on electrical equipment must be done by an approved electrical technician.
- Keep moisture away from electrical lines to prevent short-circuits.
- Check the magnet system electrical grounding before start.
- Switch the power OFF before working on the Bruker Power Supply or further equipment.

## Quench



### **WARNING**

#### **Risk of suffocation during a quench of the magnet system.**

A quench is the very fast de-energizing of the magnet by loss of its superconductivity. The stored magnetic energy is converted into heat and thus large quantities of helium evaporate. The evaporating helium will displace the breathing air. In case of not sufficient ventilation this may result in death by suffocation.

Thus

- The magnet system site must be well ventilated. In case of doubt contact Bruker Service.
- The evaporating gas may resemble smoke. Never pour water on the magnet system.

## Gas under Pressure

### WARNING

#### **Risk of injury due to gas under pressure inside the cryostat and further equipment.**

The helium vessel of the cryostat may get sealed off due to ice formation inside the helium turrets in case of non-compliance with the instruction given in this manual. This may lead to overpressure and damage of the helium or the nitrogen vessel.

Manipulations of components with gas under pressure may lead to injury and property damage.

Thus:

- In case of icing inside the helium turrets contact Bruker Service immediately.
- Release the pressure to the recommended value before working on components with gases under pressure.
- Do not seal cryogenic agent vessels of the cryostat or the transportation dewars.
- Do not connect high pressure transportation dewars to the cryostat. Completely eliminate the high pressure from the transportation dewars before connecting and transferring cryogenic agents.
- Keep the Cryogenic Refrigerator circuit closed at any time. Overpressure can be released via the safety valves of the compressor, of the rotary valve and of the cold head.



## Spontaneous Ignition and Explosion

### WARNING

#### **Risk of injury from spontaneous ignition and explosion caused by liquid oxygen.**

Pure oxygen condenses on extremely cold metal pieces. Together with oil it may ignite spontaneously. In case of fire the pure oxygen may cause an explosion.

Thus:

- Do not smoke near the magnet system.
- Do not use open flames near the magnet system.
- Keep the environment around the magnet system clean.
- Do not leave oily rags near the magnet system.



## Risk of Slippage



### **WARNING**

#### **Risk of injury from slippage.**

The accumulation of condensed water on the floor and ladders causes slippery surfaces.

Thus:

- Always wear safety shoes with an anti-slip sole.
- Be careful using ladders.
- Clean floor and ladders regularly.

## Risk of Tilting



### **WARNING**

#### **Risk of injury due to tilting of the magnet system.**

The magnet system is very sensitive to lateral forces. It may tilt.

Thus:

- Do not climb onto the magnet system.
- Do not lean items against the magnet system.
- Do not lean against the magnet system.
- Do not move the magnet system on your own.

## Heavy Weights

### WARNING

#### **Risk of damage to life and limb caused from heavy weights.**

Lifting heavy weights is life-threatening due to falling or moving parts.

Thus:



- Do not stay or work under a lifted magnet system.
- All used lifting equipment must be approved to carry the weight.
- Do not use damaged lifting equipment.
- Do not use lifting equipment without updated check tag.
- Lifting only with approved qualification.
- Obey ergonomic guidelines while lifting heavy parts.
- Protect parts against falling.
- Always wear safety shoes with approved toe caps.

## Hot Surfaces

### WARNING

#### **Risk of injury from contact with hot or cold surfaces.**

Surfaces of the Cryogenic Refrigerator parts may be hot. Skin contact with these surfaces can cause serious injuries.

Thus:



- Any work at the Cryogenic Refrigerator parts must only be performed by Bruker Service.
- Always wear protective gloves while handling Cryogenic Refrigerator parts.

## Transportation

### CAUTION

#### **Risk of injury and property damage due to incorrect transportation.**

The boxes may tilt, movement may get out of control. Thus persons may get injured and the cryostat or further equipment may be damaged.

Thus:

- Be careful while unloading and moving the boxes.
- Do not move the boxes arbitrarily.
- Pay attention to all symbols on the boxes.
- Pay attention to sharp edges and spikes of boxes and parts by using protective gloves while moving.
- Move the boxes in an upright position.
- Do not tilt the boxes.
- Prevent crossing thresholds, even if they are only a few millimeters high.
- Clean the transportation way before moving the box.
- Unpack shortly before assembling.
- The cryostat or further equipment must be protected from rain and other bad weather conditions during transportation.
- Exclusively move the cryostat in its original box.
- Do not remove the tightening straps inside the box until assembling.
- Only use the attachment points provided.
- Ensure that the cryostat is always leveled during any transportation.
- Transportation only with transportation locks attached.
- Do not move the evacuated cryostat.
- Do not move the cryostat after cool down.





## 2.5 Personal Protective Equipment

---

The personal protective equipment must be worn at any time while working on the magnet system and further equipment to prevent health hazards.



### Protective Goggles

Used to protect the eyes from injury due to flying cold liquids and parts.



### Protective Gloves

Used to protect the hands from injury caused by contact with extremely cold liquids or surfaces and for protection from injury caused by rough edges.



### Protective Clothes

Used to protect the body from injury caused by contact with extremely cold liquids or surfaces and for protection from wounds.



### Safety Shoes

Used to protect the feet from injury from falling of heavy objects. An anti-slip sole protects from injury caused by slipping and falling on slippery floor and steps. Only use safety shoes with non-ferromagnetic toe caps.

### Portable Oxygen Monitor and Alarm

Used to warn against low oxygen concentrations in surrounding air.

## 2.6 Description of Signs and Labels

Signs and labels are always related to their immediate vicinity. The following signs and labels are found on the magnet system and in the vicinity.



### Prohibition sign: No person with pacemakers!

People with pacemakers are endangered in the identified area of 0.5 mT (5 Gauss) and are not allowed to enter these areas.



### Prohibition sign: No person with implants!

People with metallic implants are endangered in the identified area of 0.5 mT (5 Gauss) and are not allowed to enter these areas.



### Prohibition sign: No watches or electronic devices!

Watches and electronic devices may be damaged in the identified area of 0.5 mT (5 Gauss).



### Prohibition sign: No credit cards or other magnetic memory!

Credit cards and magnetic memory may be damaged in the identified area of 0.5 mT (5 Gauss).



### Prohibition sign: Do not touch! Do not block!

Do not touch or block the identified area.



### Hazard warning sign: Strong magnetic field!

- No magnetic memory.
- No jewelry.
- No metallic items.



### Helium fill-in port

- Use only this port for helium refill!
- Do not leave the helium ports open for more than 5 seconds!



### Emergency exit!

- Always keep the emergency exit clear.
- Follow the arrows if necessary.
- Doors must be pushed open in escape direction.

## 2.7 Safety Devices

The supplied cryostat of the magnet system is equipped with the following safety devices:

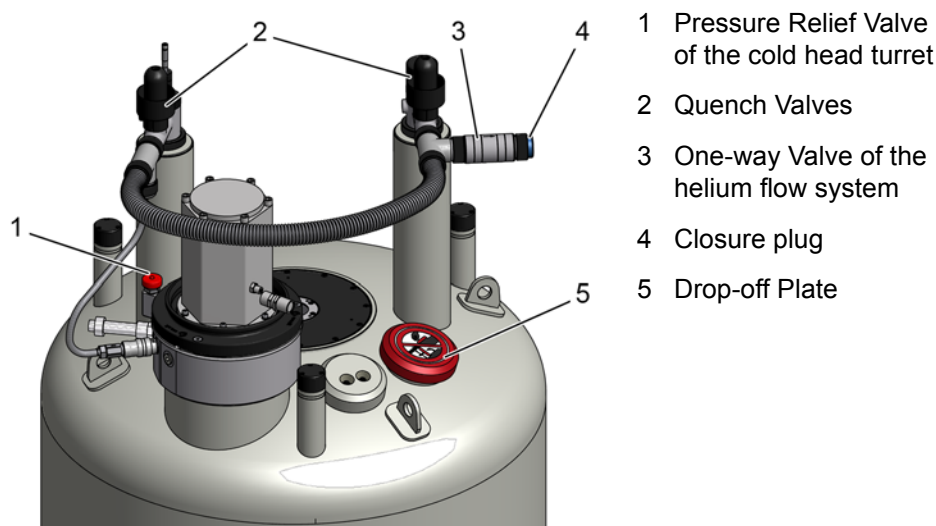

Figure 2.1: Safety devices of the cryostat

### Pressure Relief Valve

The pressure relief valve (1) is the safety device of the cold head turret. It opens at a defined pressure. In case of an accidental overpressure in the cold head turret the pressure relief valve will release the pressure smoothly.

### Quench Valve

The quench valves (2) are the safety devices of the helium vessel. They open at a defined pressure. In case of an accidental overpressure in the helium vessel the quench valves will release the pressure smoothly.

### One-way Valve

The one-way valve of the helium flow system (3) prevents air and moisture from entering the helium vessel in case of an accidental underpressure in the helium vessel.

### Closure Plug

The blue closure plug is kept on the one-way valve of the helium flow system during operational condition. The closure plug must be removed during installation of the magnet system and during helium refilling.

### Drop-off Plate

The drop-off plate (3) is a safety device of the RT vessel. If the vacuum breaks, the drop-off plate will open. In case of an accidental overpressure in the RT vessel the drop-off plate will release the pressure smoothly.

### Cryogenic Refrigerator Parts

For information about the safety devices of the Cryogenic Refrigerator parts refer to the Cryogenic Refrigerator manual.

## 2.8 Behavior in Danger and Emergency Situations

---

### Preparations

- Keep the emergency exits free at all times.
- Prepare and maintain an up-to-date list of emergency telephone numbers in the magnet system area.

### In Case of Emergency

- Leave the danger zone immediately.
- Check for sufficient ventilation in the room before entering, especially if people are showing symptoms of suffocation.
- Rescue persons from the danger zone.
- Provide medical attention for people with symptoms of suffocation.
- Start first aid immediately.
- Call the responsible contact.
- Call for medical assistance.
- Call the fire department.

### First Aid for Cold Burns

- Help the injured persons to lie down comfortably in a warm room.
- Loosen all clothing which could prevent blood circulation in the injured area.
- Pour large quantities of warm water over the affected parts.
- Cover the wound with dry and sterile gauze.
- In case of contact of liquid cryogenic agents with the eyes rinse thoroughly with clean water.
- Call for medical assistance.

## 2.9 Fire Department Notification

---

- Inform the fire department about the potential risks of a magnet system, like danger due to ferromagnetic rescue equipment near the magnet system.
- Laboratory windows which are accessible during an emergency should be clearly identified with warning signs, visible from the outside.
- Inform the fire department about the characteristics of a quench to prevent confusion with smoke.
- Never pour water over the magnet system during a quench!

# 3 Transportation

## 3.1 Safety

---

The transportation is carried out by Bruker Service or approved persons. However, it may happen that other persons have to receive the delivery of the shipping boxes. In this case it is essential to obey the instructions in this chapter and to inform these persons before.



### WARNING

Heavy Weights (see [page 23](#))



### CAUTION

Transportation (see [page 24](#))

## 3.2 Packaging

---



The cryostat is supplied in a wooden box on a pallet. It is secured inside with straps against tilting and moving.

Accessories such as the flow systems, level sensors and bore tubes are in the side compartment of the box.

The Cryogenic Refrigerator parts and the Flex Lines are supplied in boxes on a pallet.

The Magnet Stand is supplied in a wooden box on a pallet.

Figure 3.1: Packaging (without surrounding panels)

## 3.2.1 Disposal

---

Keep the original boxes for future transportation.

If no further transportation is planned, dispose of the boxes according to environmentally friendly regulations.

## 3.3 Transport Inspection

---

Investigate the delivery with regard to visible damage and completeness of delivery.

### Transport control systems

The shipping and handling monitors (“Shock Watch“, “Tilt Watch“) on the boxes show if the boxes were kicked or tilted during transportation.

### Checks

Shock Watch: Follow instructions on the label.

Tilt Watch: Follow instructions on the label.

### In case of damage

- Accept delivery with reservation.
- Make a documentation of all observable damage and add it to the transportation documents.
- Start complaint process.
- Contact Bruker Service before installation.

---

The claim for damage expires after the fixed period.



Thus:

Report damages to Bruker Service immediately after detection of damage. For contact information [see page 7](#) of this document.

---

## 3.4 Transportation by Fork Lift / Pallet Jack

A fork lift is recommended for transporting the boxes to the installation site.

**Approved Persons:** Approved forklift / pallet jack operator

**Precondition:** The fork lift / pallet jack must be approved for the transportation weight.

### Transport



Figure 3.2: Transportation by forklift - front side

1. Check the route of transport for the minimal height and width.
2. Check sufficient floor capacity on the route of transport. In case of doubt ask a stress analyst.
3. Check sufficient carrying capacity while using an elevator.
4. Position the forks between the bars of the box as shown in the figure. Make sure the side towards the operator is the one with the labels on it.



Figure 3.3: Transportation by forklift - rear side

5. Make sure the forks of the fork lift are longer than the box and project out of the back of the box as shown in the figure.
6. Now lift the fork and move the box to the site.

## 3.5 Transportation with a Crane

A crane is recommended for lifting the cryostat out of the box.

**Approved Persons:** Approved crane operator

**Precondition:** The crane must be approved for the transportation weight.

### Attachment Points

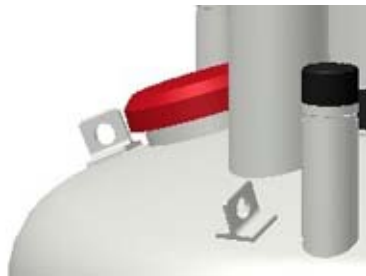

1. Exclusively use the marked eyelets as attachment points for the lifting equipment.
2. Use all eyelets for the lifting equipment.

Figure 3.4: Attachment points for lifting equipment

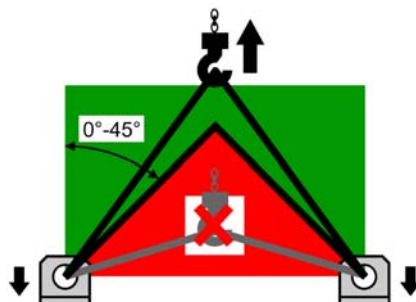

3. Follow the instructions on the label on top of the cryostat. This label gives important information about correct attachment and transportation.
4. Check for correct fastening of the lifting equipment before lifting the cryostat.
5. Make sure that any movement of the crane is as slowly as possible to avoid any damage due to acceleration.
6. Check for correct leveling of the cryostat while hanging on the crane.

Figure 3.5: Instruction label for lifting equipment



## 3.6 Storing

---

If it is necessary to store the cryostat and accessories before installation obey the following instructions:

- Store the boxes in a closed, dry and dust-free room.
- Store the boxes upright.
- Do not tilt the boxes.
- Do not unpack the supplied boxes.
- Prevent mechanical vibrations to the boxes.
- Storage temperature: 5 - 40 °C.
- Storage humidity: less than 50% @ 23 °C.

## 3.7 Disposal

---

For disposal after the life cycle please contact Bruker Service for further information. For contact information [see page 7](#) of this document.



# 4 Assembling

## 4.1 Safety

---

Approved Persons: Bruker Service only



# 5 Operation

## 5.1 Safety

---

### Approved Persons

Bruker Service, Approved Customer Personnel

### WARNING



**Magnetic Fields (see [page 18](#))**

**Cryogenic Agents (see [page 19](#))**

**Electricity (see [page 20](#))**

**Gas under Pressure (see [page 21](#))**

## 5.2 Set into Operation

---



Figure 5.1: Start the Magnet Stand

Set the magnet stand into operation by switching the pneumatic controller to UP position.



Figure 5.2: Stop the Magnet Stand

For any work at the magnet system like maintenance or refill of helium stop the magnet stand by switching the pneumatic controller to DOWN position.

# 6 Troubleshooting

Troubleshooting must be performed only with approved qualification.

In case of doubts or problems not specified in the following list contact Bruker Service immediately. For contact information [see page 7](#) of this manual.

## 6.1 Safety

---

### Approved Persons

Bruker Service, Approved Customer Personnel

### WARNING



**Magnetic Fields (see [page 18](#))**

**Cryogenic Agents (see [page 19](#))**

**Electricity (see [page 20](#))**

**Gas under Pressure (see [page 21](#))**

**Spontaneous Ignition and Explosion (see [page 21](#))**

### Personal protective equipment

- Protective goggles
- Protective gloves
- Protective clothes
- Safety shoes

## 6.2 Problem

---

### 6.2.1 During Transportation

---

Indicator	Possible reason	Solution	By
Tilt Watch / Shock Watch activated.	Careless transportation.	<ol style="list-style-type: none"> <li>1. Accept delivery with reservation.</li> <li>2. Take notes of the extent of damage in the transportation documents.</li> <li>3. Start complaint process.</li> </ol>	Approved Customer Personnel
Visible damage.	Careless transportation.	<ol style="list-style-type: none"> <li>1. Accept delivery with reservation.</li> <li>2. Take notes of the extent of damage in the transportation documents.</li> <li>3. Start complaint process.</li> </ol>	Approved Customer Personnel

### 6.2.2 During Assembling

---

Indicator	Possible reason	Solution	By
Ceiling height too low for assembling on magnet stand.	Site does not meet the required conditions.	Choose another site that meets the required conditions.	Bruker Service
Ceiling height too low for inserting the Helium Level Sensor.	Site does not meet the required conditions.	Insert the Helium Level Sensor before mounting the magnet stand.	Bruker Service
Helium bore tube and radiation shield are not concentric.	Alignment is not correct.	Check fixation of the alignment rods.	Bruker Service



Table continued

Indicator	Possible reason	Solution	By
Helium bore tube and radiation shield are not concentric.	Alignment rod is loose or broken.	Replace alignment rod <sup>a</sup> .	Bruker Service
	Reduction flange is not concentric.	Check orientation.	Bruker Service
Vacuum Valve collides with the magnet stand.	Vacuum Valve mounted incorrect.	Turn the Vacuum Valve. Be careful if the RT vessel is evacuated.	Bruker Service
Vacuum in RT vessel does not reach $5 \times 10^{-5}$ mbar within 48 hours.	O-rings may be damaged.	Check and clean O-rings and grooves; replace O-rings if necessary: <ul style="list-style-type: none"> <li>• of the Vacuum Valve</li> <li>• of the drop-off plate</li> <li>• of the reduction and sealing flanges</li> <li>• of the bottom plate <sup>a</sup></li> </ul>	Bruker Service
	Defective pumping unit or pumping line.	Check pumping unit and pumping line: A pressure below $10^{-6}$ mbar must be reached with a closed sealing plug. Replace if necessary.	Bruker Service
	Room temperature bore tube has scratches or dust on the sealing surfaces.	Check sealing surfaces on the room temperature bore tube: No scratches and no dust should be visible.	Bruker Service
	Moisture in the RT vessel.	Pump and flush the RT vessel several times with dry nitrogen gas.	Bruker Service
Super insulation touches RT vessel or bore tube or radiation shield.	Super insulation was not correctly attached during assembly.	Attach super insulation on the outer radiation shield with polyester tape <sup>a</sup> . Carefully prevent any connection between different vessels or bore tubes in the cryostat.	Bruker Service

a. For this work the bottom plate has to be removed. Check the suspension tubes of the helium vessel are not broken. Install the safety device for fall protection (not supplied). Contact Bruker Service for further information.

## 6.2.3 During Cool Down

Indicator	Possible reason	Solution	By
Precooling with liquid nitrogen continues too slowly.	Empty transportation dewar.	Refill or replace transportation dewar.	Bruker Service
	Transfer pressure too low.	Increase transfer pressure slightly.	Bruker Service
	Transportation dewar is leaky; no transfer pressure may be applied.	Check transportation dewar and replace if necessary.	Bruker Service
Precooling with liquid nitrogen continues too quickly.	Transfer pressure too high.	Stop precooling. Adjust correct transfer pressure.	Bruker Service
Vacuum in RT vessel does not reach $5 \times 10^{-5}$ mbar within 48 hours.	O-rings may be leaky.	Check and clean O-rings and grooves; replace O-rings if necessary: <ul style="list-style-type: none"> <li>• of the Vacuum Valve</li> <li>• of the drop-off plate</li> <li>• of the reduction and sealing flanges</li> <li>• of the bottom plate <sup>a</sup>.</li> </ul>	Bruker Service
	O-rings may be frozen due to contact with liquid nitrogen.	<ol style="list-style-type: none"> <li>1. Stop precooling.</li> <li>2. Warm up O-ring with warm air</li> <li>3. Wait until the vacuum is recovered.</li> <li>4. Prevent liquid nitrogen from splashing on O-rings.</li> </ol>	Bruker Service
	Defective pumping unit or pumping line.	Check pumping unit and pumping line: A pressure below $10^{-6}$ mbar must be reached with a closed sealing plug. Replace if necessary.	Bruker Service

a. For this work the bottom plate has to be removed. Check the suspension tubes of the helium vessel are not broken. Install the safety device for fall protection (not supplied). Contact Bruker Service for further information.

Table continued

Indicator	Possible reason	Solution	By
RT vessel becomes cold and wet.	Vacuum is broken or less than $1 \times 10^{-3}$ mbar.	<ul style="list-style-type: none"> <li>Do not remove pumping unit until filling with liquid helium is finished.</li> <li>Continue as described in problem <i>Vacuum in RT vessel does not reach <math>5 \times 10^{-5}</math> mbar.</i></li> </ul>	Bruker Service
	Cold leak after transportation.	<ol style="list-style-type: none"> <li>Stop cool down.</li> <li>Warm up cryostat.</li> </ol>	Bruker Service
Cold spot in the RT bore.	Alignment not correct.	<ol style="list-style-type: none"> <li>Stop cool down.</li> <li>Warm up cryostat.</li> <li>Align the vessels.</li> </ol>	Bruker Service
The helium flow system becomes very cold and icy during pumping and flushing with helium gas.	Liquid nitrogen remains in the helium vessel, boiling off strongly during pumping.	<ol style="list-style-type: none"> <li>Stop pumping.</li> <li>Carefully remove all liquid nitrogen through the precooling tube.</li> <li>Check with the dip-stick to be sure that the helium vessel is completely empty of liquid nitrogen and of frozen nitrogen (nitrogen ice).</li> </ol>	Bruker Service
After some intervals of pumping and flushing it is not possible to reach a vacuum in the range of 1 mbar.	The globes in the quench valves are not fitting correctly in the O-rings and thus the quench valves are leaky.	<ol style="list-style-type: none"> <li>Stop pumping.</li> <li>Remove frozen air and frozen moisture with warm helium gas.</li> <li>Slightly grease the O-rings and check the position of the globes.</li> <li>Check with the dip-stick to be sure that the helium vessel is completely empty of liquid nitrogen and of nitrogen ice.</li> </ol>	Bruker Service
	Liquid nitrogen remains in the helium vessel, boiling off strongly during pumping.	<ol style="list-style-type: none"> <li>Stop pumping.</li> <li>Carefully remove all liquid nitrogen through the precooling tube.</li> <li>Check with the dip-stick to be sure that the helium vessel is completely empty of liquid nitrogen and of frozen nitrogen (nitrogen ice).</li> </ol>	Bruker Service

Table continued

Indicator	Possible reason	Solution	By
Nitrogen ice in the helium vessel.	Pumping intervals during pumping and flushing were too long and remaining nitrogen was boiling off and got frozen.	<ol style="list-style-type: none"> <li>1. Warm up the magnet coil with warm helium gas through the precooling tube until the whole coil is warmer than 90 K.</li> <li>2. Repeat pumping and flushing and carefully check with the dipstick to be sure that the helium vessel is completely empty of liquid nitrogen and of frozen nitrogen (nitrogen ice).</li> </ol>	Bruker Service
Transfer of liquid helium does not start.	Empty transportation dewar.	Refill or replace transportation dewar.	Bruker Service
	The transfer pressure in the transportation dewar is too low.	Increase the transfer pressure.	Bruker Service
	The transportation dewar is leaky, there is no transfer pressure built up.	Check the transportation dewar for leakage. Re-tighten all connections.	Bruker Service
	The siphon or the helium transfer line are blocked with ice.	Check the siphon and helium transfer line for blockages, remove ice with warm helium gas.	Bruker Service
The cool down of the magnet coil does not continue although helium is transferred.	The helium transfer line is defective.	Check the helium transfer line for icing. If there are cold spots visible, replace the helium transfer line.	Bruker Service
	The extension piece is not mounted on the helium transfer line.	Mount the extension piece on the helium transfer line. Check the helium transfer line to be inserted completely into the siphon.	Bruker Service

Table continued

Indicator	Possible reason	Solution	By
The zero reading of the Helium Level Sensor cannot be adjusted at the beginning of cooling down with liquid helium.	The Helium Level Sensor is not connected correctly with the connector in the helium flow system.	Check the connection in the helium fill-in turret between Helium Level Sensor and connector.	Bruker Service
	The Helium Level Sensor is defective.	Check the Helium Level Sensor with the 0 % calibration plug.	Bruker Service
The helium level does not reach 100 % after cooling down.	Empty transportation dewar, helium transfer stopped.	Refill or replace transportation dewar.	Bruker Service
	The Helium Level Sensor is disturbed by the extension piece of the transfer line.	<ol style="list-style-type: none"> <li>1. Stop the liquid helium transfer.</li> <li>2. Remove the transfer line.</li> <li>3. Measure the helium level after some minutes without the transfer line.</li> </ol>	Bruker Service
2 days after cool down the $T_{RS}$ is still higher than set value (alarm of CMU).	Cryogenic Refrigerator performance not sufficient.	See “ <b>During Operation of the Cryogenic Refrigerator</b> ” on page 71.	Bruker Service
	Alarm default settings of the CMU or MICS not correct.	Check set values (refer to the manual of the CMU and of MICS).	Bruker Service
	Cold head not mounted correctly.	See chapter "Mounting the Cryogenic Refrigerator Parts" in the Service Manual.	Bruker Service

## 6.2.4 During Energizing and Shimmiing

Indicator	Possible reason	Solution	By
The current lead cannot be inserted completely into the connector.	The connector is covered with ice. (frozen moisture or nitrogen ice).	Carefully remove the ice with warm helium gas. To remove small ice spots use the dipstick or the precooling tube as tubing for the warm helium gas.	Bruker Service
	The shorting plug was not removed.	Remove the shorting plug with the shorting plug tool.	Bruker Service
	The orientation of the current lead is not correct.	Turn the current lead carefully until it can be inserted correctly into the connector.	Bruker Service
Main coil heater test fails.	Power Supply defective.	Replace the Power Supply.	Bruker Service
	Connector or cables defective.	Clean connectors or replace cables if necessary.	Bruker Service
Setting of sense voltage fails.	The main coil heater switch is "OFF". The main coil switch is not opened.	Switch the main coil heater to "ON" and check the main coil heater current to be adjusted correctly.	Bruker Service
	The main coil heater current is not correct. The main coil switch is not opened.	Adjust main coil heater current correctly.	Bruker Service
	The auxiliary shorting plug is inserted in the current lead turret by mistake and makes a short circuit across the main coil.	Remove the auxiliary shorting plug and insert it in the helium fill-in turret.	Bruker Service
Current lead cannot be removed.	The connector is covered with ice (frozen moisture or nitrogen ice).	Carefully remove the ice with warm helium gas over the helium flow system. To remove small ice spots from the connector use the dip-stick or the precooling tube as tubing for the warm helium gas.	Bruker Service

Table continued

Indicator	Possible reason	Solution	By
Shorting plug cannot be removed.	The connector is covered with ice (frozen moisture or nitrogen ice).	Carefully remove the ice with warm helium gas. To remove small ice spots use the dip-stick or the precooling tube as tubing for the warm helium gas.	Bruker Service
The magnet system quenches.	Loss of superconductivity.	See <b>“After a Quench” on page 76.</b>	Bruker Service
	The helium level was too low for energizing, cycling, shimming, de-energizing.	See <b>“After a Quench” on page 76.</b>	Bruker Service
	The Power Supply is defective. The main current is oscillating.	Replace the Power Supply.	Bruker Service
The main coil switch cannot be closed on field.	The helium level is too low for energizing. The main coil switch is not covered with liquid helium.	Never try to energize the magnet with less than the "minimum allowed level during energizing" in the helium vessel.	Bruker Service
	The Power Supply is defective. The main current is oscillating.	Replace the Power Supply.	Bruker Service
Shim current cannot be set correctly.	The control cable is not connected correctly to the current lead or to the Power Supply.	Connect the control cable correctly to current lead and Power Supply.	Bruker Service
	Switch “Main Coil/OFF/Shim Coil” in wrong position.	Change the switch position.	Bruker Service
Shims do not affect the NMR signal.	Shim heater current is not correct. The shim switches are not opened.	Set the shim heater current to the specified value (see “Heater Currents” on page 106.	Bruker Service

Table continued

Indicator	Possible reason	Solution	By
Magnet system does not reach specification.	Magnetic material inside RT bore tube.	Carefully clean the RT bore tube.	Bruker Service
	Large ferromagnetic parts near the magnet system.	<ol style="list-style-type: none"> <li>1. Keep the maximum possible distance between the magnet system and ferromagnetic parts.</li> <li>2. Repeat shimming.</li> </ol>	Bruker Service

## 6.2.5 During Operation of the Magnet Stand

In case of doubt contact Bruker Service and refer to the manual of the Magnet Stand.

Indicator	Possible reason	Solution	By
The NMR spectrum shows massive disturbances.	The pneumatic controller is in DOWN position.	Switch pneumatic controller to UP position.	Approved Customer Personnel
	Magnet system has direct mechanical contact with the floor via accessories or cables.	Identify and eliminate contact point. Arrange cables in loose S- or U-shapes.	Approved Customer Personnel
		If the problem is still not solved, contact Bruker Service.	Approved Customer Personnel
	Magnet system has physical contact to the magnet stand.	Check leveling; adjust if necessary.	Bruker Service
	Piston of the isolator is not centric or touches its casing.	Align magnet stand.	Bruker Service
	T-safety brackets touches the pillar.	Align magnet stand.	Bruker Service
	Floor vibrations in horizontal and vertical direction.	Replace air damped isolators with air piston isolators.	Bruker Service



Table continued

Indicator	Possible reason	Solution	By
The isolator of the magnet stand does not reach the operating position.	Pneumatic controller in DOWN position.	Switch pneumatic controller to UP position.	Approved Customer Personnel
	The pressure of the gas supply is too low.	Check the pressure of the gas supply. It must be in the range of 5 to 8 bar (70 to 112 psi).	Approved Customer Personnel
		If the problem is still not solved, contact Bruker Service.	Approved Customer Personnel
	The magnet system is not leveled correctly.	Switch off the pneumatic isolators. Check the leveling of the cryostat.	Bruker Service
	Defective leveling valve.	Replace leveling valve or isolator.	Bruker Service
	Defective membrane of an isolator.	Replace leveling valve or isolator.	Bruker Service
Magnet system achieves working position jerkily.	Piston is not centric or touches its casing.	Align magnet stand.	Bruker Service
Audible loss of gas.	Defective membrane or defective leveling valve of an isolator.	Replace leveling valve or isolator.	Bruker Service
	Hose connector is defective or loose.	Insert hoses correctly and tighten screws.	Bruker Service
Velocity of lifting or lowering too high.	Wrong adjustment of the flow control valve.	Close restrictor of the flow control valve completely; then open it a half turn.	Bruker Service

## 6.2.6 During Standard Operation

Indicator	Possible reason	Solution	By
The helium boil off is too high.	The Helium Level Sensor is permanently on (service mode) or used often.	Switch off Helium Level Sensor. Reduce helium level measurement (measuring the helium level causes some additional helium boil off due to the heat input of the Helium Level Sensor).	Approved Customer Personnel
	The atmospheric pressure is decreasing.	Usual behavior. Watch helium boil off daily.	Approved Customer Personnel
		If the problem is still not solved, contact Bruker Service.	Approved Customer Personnel
	Vacuum reduced.	Rebuild vacuum, see chapter "Rebuilding Vacuum" in the Service Manual.	Bruker Service
	The radiation baffles are not inserted in the current lead turret.	Insert the radiation baffles into the current lead turret.	Bruker Service

Table continued

Indicator	Possible reason	Solution	By
Quench	Loss of superconductivity.	See “After a Quench” on page 76. Contact Bruker Service immediately.	Approved Customer Personnel
Cold spots within the RT bore.	Alignment not correct.	Contact Bruker Service.	Approved Customer Personnel
RT vessel is wet and cold.	Vacuum reduced.	Contact Bruker Service immediately.	Approved Customer Personnel
Not correct helium level warning from MICS GUI.	Helium Level Sensor defective.	Contact Bruker Service immediately.	Approved Customer Personnel
		<b> WARNING:</b> <b>Low Temperature</b>	
Not correct helium level warning out of MICS GUI.	Helium Level Sensor defective.	Replace Helium Level Sensor (see chapter "Replacement of the Helium Level Sensor" in the Service Manual).	Bruker Service

























# Troubleshooting

The following tables summarize the display of the CMU and of the MICS interface on the left side (on even pages). The reason and solution is given on the right side (on odd pages).

The alert message sent by E-mail gives detailed information on which sensor value caused the alert. For further information refer to the MICS User Manual.



In case of a complete failure of the cryogenic refrigerator, the helium content of the helium vessel will be sufficient to cool the magnet system for **at least 7 days**. If solving the issue takes longer than 7 days, it will be necessary to refill helium at all times to ensure it stays at the required level.

Display CMU				Interface MICS					
Cooling	MICS	Com-pressor	Buzzer	Message (Window, E-mail)	JAC	CMU	CCA	T <sub>RS</sub>	He
 blink	 bright	 bright		Cooler function not optimal. Call Bruker Service	 bright	 bright	 bright	 bright	 bright
 blink	 bright	 bright		Cooler function not optimal. Call Bruker Service	 bright	 bright	 bright	 bright	 bright
 blink	 bright	 bright		Cooler function not optimal. Call Bruker Service	 bright	 bright	 bright	 bright	 bright

Sensor/Value Log files in MICS	Possible reason	Solution	By
$U_{PT100-RS0}$ out of range	Cable 4 Pin Cryostat to CMU disconnected.	Check connections.	Approved Customer Personnel
	Cable 4 Pin Cryostat to CMU defective.	Replace cable.	Bruker Service
	Sensor defective.	Disable CMU Mag RS sensor in CMU Service.	Bruker Service
$T_{RS0} < T_{min}$	Cable 4 Pin Cryostat to CMU disconnected.	Check connections	Approved Customer Personnel
	Cable 4 Pin Cryostat to CMU defective.	Replace cable.	Bruker Service
	Sensor defective.	Disable CMU Mag RS sensor in CMU Service GUI.	Bruker Service
$T_{RS0} > T_{max}$	Cable 4 Pin Cryostat to CMU disconnected.	Check connections.	Approved Customer Personnel
	Cable 4 Pin Cryostat to CMU defective.	Replace cable.	Bruker Service
	Sensor defective	Disable CMU Mag RS sensor in CMU Service GUI.	Bruker Service
	Cooling power too low.	Check pressure values on the compressor match specifications. Refer to "During Operation of the Cryogenic Refrigerator" on page 71.	Bruker Service
	Gap on first stage too big.	Check gap. Refer to chapter "Cooling down to 4.2 K" in the Service Manual.	Bruker Service

Table continued

Display CMU				Interface MICS					
Cooling	MICS	Com-pressor	Buzzer	Message (Window, E-mail)	JAC	CMU	CCA	T <sub>RS</sub>	He
 blink	 bright	 bright		Cooler function not optimal. Check system status	 bright	 bright	 bright	 bright	 bright
 blink	 bright	 bright		Cooler function not optimal. Call Bruker Service	 bright	 bright	 bright	 bright	 bright
 blink	 bright	 bright		Cooler function not optimal. Call Bruker Service	 bright	 bright	 bright	 bright	 bright

Table continued

Sensor/Value Log files in MICS	Possible reason	Solution	By
$U_{PT100\ RS1}$ out of range	Cable 4 Pin Cryostat to BSMS Mag RS disconnected.	Check connections.	Approved Customer Personnel
	BSMS Mag RS cable defective.	Replace cable.	Bruker Service
	BSMS Mag RS defective.	Replace BSMS Mag RS box.	Bruker Service
	Sensor defective.	Disable sensor in CMU Service GUI.	Bruker Service
$T_{RS1} < T_{min}$	Cable 4 Pin Cryostat to VTA Mag RS disconnected.	Check connections.	Approved Customer Personnel
	Mag RS box cable defective.	Replace Mag RS box cable.	Bruker Service
	Mag RS box defective.	Replace Mag RS box.	Bruker Service
	Sensor defective.	Disable sensor in CMU Service GUI.	Bruker Service
$T_{RS1} > T_{max}$	Cable 4 Pin Cryostat to VTA Mag RS disconnected.	Check connections.	Approved Customer Personnel
	Cable 4 Pin Cryostat to Mag RS Box defective.	Replace cable.	Bruker Service
	Sensor defective.	Disable BSMS Mag RS in CMU Service GUI.	Bruker Service
	Cooling power too low.	Check if pressure values on compressor meet the specifications. Refer to "During Operation of the Cryogenic Refrigerator" on page 71.	Bruker Service
	Gap on first stage too big.	Check gap. Refer to chapter "Cooling down to 4.2 K" in the Service Manual.	Bruker Service

Table continued

















Display CMU				Interface MICS					
Cooling	MICS	Com-pressor	Buzzer	Message (Window, E-mail)	JAC	CMU	CCA	T <sub>RS</sub>	He
 blink	 bright	 bright		Helium measurement failed. Check system status	 bright	 bright	 bright	 bright	 bright
 blink	 bright	 blink		Compressor off. Check compressor status	 bright	 bright	 bright	 bright	 bright



Table continued

Sensor/Value Log files in MICS	Possible reason	Solution	By
U <sub>He</sub> -Sensor out of range	Cable from helium sensor to console disconnected.	Check connections.	Approved Customer Personnel
	Electronic failure.	Check helium log file.	Approved Customer Personnel
	Calibration missing.	Calibrate helium sensor in MICS GUI.	Bruker Service
	Cable from sensor to console defective.	Replace cable.	Bruker Service
	Helium sensor defective.	Replace helium sensor.	Bruker Service
Compressor off	Compressor power supply failure.	Check connections.	Approved Customer Personnel
	Cooling water failure.	Check water chiller.	Bruker Service
	Compressor not operating.	Check compressor. Refer to the manual of the cryogenic refrigerator.	Bruker Service

Table continued













































Display CMU				Interface MICS					
Cooling	MICS	Com-pressor	Buzzer	Message (Window, E-mail)	JAC	CMU	CCA	T <sub>RS</sub>	He
 blink	 bright	 blink		<b>Compressor function not optimal. Call Bruker Service</b>	 bright	 bright	 bright	 bright	 bright
 blink	 bright	 blink		<b>Cooling water temperature too high. Check chiller</b>	 bright	 bright	 bright	 bright	 bright
 blink	 bright	 blink		<b>Compressor function not optimal. Call Bruker Service</b>	 bright	 bright	 bright	 bright	 bright
 blink	 bright	 blink		<b>Cooling water flow too low. Check chiller</b>	 bright	 bright	 bright	 bright	 bright
 bright	 bright	 bright		<b>CMU E-mail problem. Check settings/connection</b>	 bright	 bright	 bright	 bright	 bright
-/-	-/-	-/-		<b>Cooler function not optimal. Call Bruker Service</b>	 bright	 bright	 bright	 bright	 bright

Table continued

Sensor/Value Log files in MICS	Possible reason	Solution	By
U <sub>T</sub> , Cooling Water out of range	Cable at CCA or CMU disconnected.	Check connections.	Approved Customer Personnel
	CCA cable or CCA defective.	Replace CCA cable or CCA.	Bruker Service
T <sub>Cooling Water</sub> > T <sub>max</sub>	Cooling water problem.	Check chiller loop.	Approved Customer Personnel
U <sub>Q</sub> , Cooling Water out of range	Cable at CCA or CMU disconnected.	Check connections.	Approved Customer Personnel
	CCA cable or CCA defective.	Replace CCA cable or CCA.	Bruker Service
Q <sub>Chiller</sub> < Q <sub>min</sub>	Cooling water problem.	Check chiller loop.	Approved Customer Personnel
JAC cannot send E-mail.	E-mail setting incorrect.	Check settings.	Approved Customer Personnel
	LAN cable disconnected.	Check LAN connections.	Approved Customer Personnel
JAC internal error.	JAC defective.	Reboot JAC. If not solved, replace JAC.	Bruker Service

Table continued



























Display CMU				Interface MICS					
Cooling	MICS	Com-pressor	Buzzer	Message (Window, E-mail)	JAC	CMU	CCA	T <sub>RS</sub>	He
-/-	-/-	-/-		<b>Power failure. RZ system off</b>	 bright	 bright	 bright	 bright	 bright
-/-	-/-	-/-		<b>Connection to JAC failed. Check system status</b>  <i>Remarks: compressor switched off to avoid underpressure</i>	 bright	 bright	 bright	 bright	 bright
 blink	 bright	 bright		<b>Connection to BSMS failed. Check BSMS status</b>	 bright	 bright	 bright	 bright	 bright
 blink	 bright	 bright		<b>Cooler function not optimal. Check system status</b>	 bright	 bright	 bright	 bright	 bright

Table continued

Sensor/Value Log files in MICS	Possible reason	Solution	By
JAC power failure.	CMU power supply disconnected or JAC power switch off.	Check JAC and CMU connections and JAC switch.	Approved Customer Personnel
	CMU cable disconnected.	Check CMU connections.	Approved Customer Personnel
	JAC power supply cable defective.	Replace cable.	Bruker Service
	CMU cable defective.	Replace cable.	Bruker Service
	JAC power supply defective.	Replace power supply.	Bruker Service
JAC connection missing.	CMU power supply disconnected or JAC power switch off.	Check JAC and CMU connections and JAC switch.	Approved Customer Personnel
	CMU-JAC power cable disconnected.	Check connections.	Approved Customer Personnel
	JAC power supply cable defective.	Replace cable.	Bruker Service
	CMU-JAC LAN cable defective.	Replace cable.	Bruker Service
	CMU power supply defective.	Replace power supply.	Bruker Service
BSMS connection missing.	BSMS LAN cable disconnected.	Check BSMS LAN connections.	Approved Customer Personnel
	BSMS or console switched off.	Restart BSMS or console.	Approved Customer Personnel
ELCB firmware too old.	ELCB firmware too old.	Download the newest ELCB firmware on ELCB.	Approved Customer Personnel

# Troubleshooting

Table continued













































Display CMU				Interface MICS					
Cooling	MICS	Com-pressor	Buzzer	Message (Window, E-mail)	JAC	CMU	CCA	T <sub>RS</sub>	He
 blink	 bright	 bright		Heater power too high. Call Bruker Service	 bright	 bright	 bright	 bright	 bright
 blink	 bright	 bright		Heater power too low. Call Bruker Service	 bright	 bright	 bright	 bright	 bright
 blink	 bright	 bright		Cooler function not optimal. Call Bruker Service	 bright	 bright	 bright	 bright	 bright
 blink	 bright	 bright		Cooler off. Helium evaporating. Call Bruker Service	 bright	 bright	 bright	 bright	 bright
 blink	 bright	 bright		Helium pressure too high. Call Bruker Service	 bright	 bright	 bright	 bright	 bright

Table continued

Sensor/Value Log files in MICS	Possible reason	Solution	By
Heater power above set value.	Pressure is below set value.	Check for leaks in the helium flow system.	Bruker Service
	Pressure cannot be reached due to leak.	Check for leaks in the helium flow system.	Bruker Service
Heater power below set value.	Gas pressure inside compressor too low.	Check gas pressure values of the compressor. Refill helium if not correct.	Bruker Service
	Rotary valve defective.	Check operation status of the rotary valve. Replace rotary valve if necessary.	Bruker Service
	Cold head power too low.	Replace cold head.	Bruker Service
Helium pressure below set value.	Cable from pressure sensor to CMU disconnected.	Check connections.	Approved Customer Personnel
	CMU controller defective.	Replace CMU.	Bruker Service
	Heater defective.	Check heater resistance. If broken replace heater.	Bruker Service
Helium pressure below lowest limit.	Cable from pressure sensor to CMU disconnected.	Check connections.	Approved Customer Personnel
	CMU controller defective.	Replace CMU.	Bruker Service
	Heater defective.	Check heater resistance. If broken replace heater.	Bruker Service
Helium pressure above set value.	Cooling power too low.	Check heater power. If zero, refer to Heater power < 50 mW.	Bruker Service

Table continued



























Display CMU				Interface MICS					
Cooling	MICS	Com-pressor	Buzzer	Message (Window, E-mail)	JAC	CMU	CCA	T <sub>RS</sub>	He
 blink	 bright	 bright		Cooler off. Helium evaporating. Call Bruker Service  <i>Remarks: compressor switched off to avoid underpressure after 15 min</i>	 bright	 bright	 bright	 bright	 bright
-/-	-/-	-/-		Connection to CMU failed. Check CMU status  <i>Remarks: compressor switched off to avoid underpressure after 15 min</i>	 bright	 bright	 bright	 bright	 bright
 blink	 bright	 blink		Connection to CCA failed. Check CCA status  <i>Remarks: compressor switched off to avoid underpressure after 15 min</i>	 bright	 bright	 bright	 bright	 bright
 blink	 blink	 bright		No message	-/-	-/-	-/-	-/-	-/-



Table continued

Sensor/Value Log files in MICS	Possible reason	Solution	By
Pressure out of range.	Cable from pressure sensor to CMU disconnected.	Check connections.	Approved Customer Personnel
	Pressure sensor defective.	Replace pressure sensor.	Bruker Service
CMU off.	CMU cable disconnected.	Check connections.	Approved Customer Personnel
	CMU cable defective.	Replace CMU cable.	Bruker Service
	CMU defective.	Replace CMU.	Bruker Service
CCA off.	CCA cable disconnected.	Check connections.	Approved Customer Personnel
	CCA cable defective.	Replace CCA cable.	Bruker Service
	CCA defective.	Replace CCA.	Bruker Service
MICS or PC off.	Console workstation down.	Restart workstation	Approved Customer Personnel
	MICS software not running.	Restart MICS. MICS has to run at all times.	Approved Customer Personnel

# Troubleshooting

Table continued

Display CMU				Interface MICS					
Cooling	MICS	Com-pressor	Buzzer	Message (Window, E-mail)	JAC	CMU	CCA	T <sub>RS</sub>	He
 blink	 bright	 bright		<b>Helium measurement failed. Check system status</b>	 bright	 bright	 bright	 bright	 bright
 blink	 bright	 bright		<b>Helium level below optimum. Refill helium</b>	 bright	 bright	 bright	 bright	 bright
 blink	 bright	 bright		<b>Helium level low. Refill helium</b>	 bright	 bright	 bright	 bright	 bright

Table continued

Sensor/Value Log files in MICS	Possible reason	Solution	By
Data update missing.	Cable from helium sensor disconnected.	Check connections.	Approved Customer Personnel
	Calibration missing.	Calibrate helium sensor in MICS GUI.	Bruker Service
Helium level < 85 %.	Helium leak.	Refill helium. Call Bruker Service.	Approved Customer Personnel
	Cooling power too low.	Check pressure values on compressor with specifications. Refer to "During Operation of the Cryogenic Refrigerator" on page 71.	Bruker Service
	Rotary valve defective.	Check operation status of the rotary valve. Replace rotary valve if necessary.	Bruker Service
	Cold head power too low.	Replace cold head.	Bruker Service
Helium level < 70 %.	Helium leak.	Refill helium. Call Bruker Service.	Approved Customer Personnel
	Cooling power too low.	Check pressure values on compressor with specifications. Refer to "During Operation of the Cryogenic Refrigerator" on page 71.	Bruker Service
	Rotary valve defective.	Check operation status of the rotary valve. Replace rotary valve if necessary.	Bruker Service
	Cold head power too low.	Replace cold head.	Bruker Service

Table continued









Display CMU				Interface MICS					
Cooling	MICS	Com-pressor	Buzzer	Message (Window, E-mail)	JAC	CMU	CCA	T <sub>RS</sub>	He
 blink	 bright	 bright		Helium level too low. Refill helium	 bright	 bright	 bright	 bright	 bright

Table continued

Sensor/Value Log files in MICS	Possible reason	Solution	By
Helium level < 40 %.	Helium leak.	Refill helium. Call Bruker Service immediately.	Approved Customer Personnel
	Cooling power too low.	Check pressure values on compressor with specifications. Refer to "During Operation of the Cryogenic Refrigerator" on page 71.	Bruker Service
	Rotary valve defective.	Check operation status of the rotary valve. Replace rotary valve if necessary.	Bruker Service
	Cold head power too low.	Replace cold head.	Bruker Service

## 6.2.7 During De-energizing and Warming up

Indicator	Possible reason	Solution	By
The magnet system quenches during de-energizing.	The helium level was too low for de-energizing.	Refill helium at least to the minimum allowed level (see "Helium Level Graph" on page 91.	Bruker Service
	The Power Supply is defective.	Replace Power Supply.	Bruker Service
	The main current is oscillating.	Replace Power Supply.	Bruker Service
The shim current cannot be set correctly.	The control cable is not connected correctly to the current lead and/or the Power Supply.	Connect the control cable to the current lead and to the Power Supply correctly.	Bruker Service
	The switch "Main Coil/OFF/Shim Coil" is not on the "Shim Coil" position.	Switch "Main Coil/OFF/Shim Coil" on the "Shim Coil" position.	Bruker Service
High helium flow after breaking vacuum.	Remaining cryogenic agents in the inner vessels.	Remove liquid helium.	Bruker Service
Vacuum still remains after 12 hours.	Vacuum Valve is closed.	Open Vacuum Valve. Block it if necessary.	Bruker Service
RT vessel is wet and cold.	Cryostat is still cold.	Wait until RT vessel is dry and warm. Check PT 100 temperature sensors.	Bruker Service
RT bore wet and cold before disassembling.	Cryostat is still cold.	Wait one more day. Do not open a cryostat before the room temperature bore tube is warm and dry!	Bruker Service

## 6.2.8 During Operation of the Cryogenic Refrigerator



In case of a complete failure of the Cryogenic Refrigerator, the helium contained in the helium vessel will be sufficient to cool the magnet for at least 7 days. If solving the issue takes longer, it is necessary to refill helium at all times.



In case of any issue or failure specified in the following table where the intervention of the operator is necessary, make sure the start button of the compressor is switched off and the power supply of the compressor is disconnected.

After resolving the issue, connect the power supply and push the start button of the compressor.

If the compressor does not start immediately, press the temperature and the pressure switch for reset. Then press the start button of the compressor.

For problems not specified in this chapter refer to the supplied manual of the Cryogenic Refrigerator.

Indicator	Possible reason	Solution	By
Compressor is not operating.	No power supply or power supply interrupted.	Check the power supply to the compressor and verify that it meets the system requirements.	Approved Customer Personnel
	Circuit breakers OFF.	Ensure that both circuit breakers, located on the front panel of the compressor, are ON.	Approved Customer Personnel
	"Compressor Error" message displayed on the display screen.	Refer to the supplied user manual of the cryocooler package for error message diagnostic.	Approved Customer Personnel

# Troubleshooting

Table continued

Indicator	Possible reason	Solution	By
Compressor is operating, but no pressure fluctuation visible (needles at the pressure gauges are not oscillating).	Motor cord not connected at the compressor.	Connect the motor cord to the compressor.	Approved Customer Personnel
	Motor cord not connected.	Check the motor cord connection at the coupling in the middle of the motor cord at 10 m (skip, if motor cord is one piece).	Approved Customer Personnel
		<b>⚠ WARNING:</b> <b>Hot Surfaces</b>	
	Motor cord not connected at the rotary valve.	<ol style="list-style-type: none"> <li>1. Remove the noise protection cover of the Rotary Valve Column.</li> <li>2. Check the motor cord connection at the rotary valve.</li> <li>3. Connect motor cord if necessary.</li> <li>4. Attach the noise protection cover.</li> </ol>	Approved Customer Personnel
		If the problem is still not solved, contact Bruker Service.	Approved Customer Personnel
	Aeroquip® connectors of the flex lines not correctly tightened at the compressor.	Tighten the Aeroquip® connectors correctly.	Bruker Service
	High and low pressure helium flex line reversed at the compressor.	Check that the flex lines are mounted correctly at the compressor high and low pressure port.	Bruker Service
Motor cord defective.	Check electrical connection of all four conductors in the motor cord. If not correct, replace the motor cord.	Bruker Service	



Table continued

Indicator	Possible reason	Solution	By
<p><i>Continue of:</i></p> <p>Compressor is operating, but no pressure fluctuation visible (needles at the pressure gauges are not oscillating).</p>	Aeroquip® connectors of the flex lines tightened not correctly at the rotary valve.	Tighten the Aeroquip® connectors correctly.	Bruker Service
	High and low pressure helium flex line reversed at the rotary valve.	Check if the flex lines are mounted correctly at the rotary valve high and low pressure port.	Bruker Service
	Rotary valve is defective.	If possible, check if the rotary valve sound has changed since installation. If the typical sound is missing, the rotary valve might be defective and has to be replaced. Replace the rotary valve.	Bruker Service
<p>Compressor is operating, pressure fluctuation is visible at the pressure gauges, but drops shortly after start.</p>	Water chiller not running.	Check possible reasons why the water cooler is not running. Start the water cooler.	Approved Customer Personnel
	Cooling water flow too low.	Check cooling water supply is sufficient (refer to the supplied manual of the Cryogenic Refrigerator).	Approved Customer Personnel
	Cooling water flow too low due to icing, blockage, fouling or leak in the cooling water lines.	Search for possible reasons of the disturbance. Check the cooling water supply is as specified in the supplied manual of the Cryogenic Refrigerator and/or the manual of the water chiller.	Approved Customer Personnel
	Not correct environmental temperature (too high or too low).	Check the environmental temperature is as specified.	Approved Customer Personnel
Not correct water temperature (too high or too low).	Check the cooling water temperature is as specified.	Approved Customer Personnel	

Table continued

Indicator	Possible reason	Solution	By	
Compressor is operating, cryogenic refrigeration not sufficient.		Exclude all previous reasons of this list.	Approved Customer Personnel	
	Not correct maintenance.	Check periodic maintenance work was made according to schedule (see “ <b>Maintenance Timetable</b> ” on page 80).	Approved Customer Personnel	
		If the problem is still not solved, contact Bruker Service.	Approved Customer Personnel	
	<b>⚠ WARNING:</b> <b>Hot Surfaces</b>			
	Connecting line between rotary valve and cold head not mounted correctly at the cold head.	Tighten the Aeroquip® connectors correctly. Check if the O-rings of the fitting are in correct position (see chapter "Mounting the Rotary Valve and Flex Lines" in the Service Manual).	Bruker Service	
	Low helium pressure inside the compressor helium circuit.	Recharge helium of high purity (He 5.0, 99.999 %). Refer to the supplied manual of the Cryogenic Refrigerator.	Bruker Service	
	Low helium pressure due to small leak inside the compressor helium circuit.	<ol style="list-style-type: none"> <li>1. Leak detection with leak detector at connectors, flex lines, inside compressor, cold head, rotary valve, connecting line.</li> <li>2. Eliminate leak, if possible.</li> <li>3. Recharge helium of high purity (He 5.0, 99.999%). Refer to the supplied manual of the Cryogenic Refrigerator.</li> </ol>	Bruker Service	
High helium pressure inside the compressor.	Vent helium to the set value. Refer to the supplied manual of the Cryogenic Refrigerator.	Bruker Service		

Table continued

Indicator	Possible reason	Solution	By
<p><i>Continue of:</i></p> <p>Compressor is operating, cryogenic refrigeration not sufficient.</p>	Cold head contaminated.	Remount the cold head. Pump and flush the cold head. See chapter " <b>Procedure in case of Cryogenic Refrigerator failure</b> " on page 78.	Bruker Service
	Cold head defective.	Replace the cold head. See chapter " <b>Procedure in case of Cryogenic Refrigerator failure</b> " on page 78.	Bruker Service
	Cryogenic Refrigerator contaminated.	Replace the complete Cryogenic Refrigerator. See chapter " <b>Procedure in case of Cryogenic Refrigerator failure</b> " on page 78 and see chapter " <b>Mounting the Cryogenic Refrigerator Parts</b> " in the Service Manual.	Bruker Service

## 6.3 Troubleshooting Work

---

### 6.3.1 After a Quench

---



A quench is the very fast de-energizing of the magnet by loss of its superconductivity. The stored magnetic energy is converted into heat, which promotes rapid evaporation of large quantities of helium. If a quench occurs contact Bruker Service immediately.

Figure 6.1: Magnet system during a quench



#### **⚠ WARNING**

**Cryogenic Agents (see [page 19](#))**

**Quench (see [page 20](#))**

#### **Quench while magnet is in persistent mode:**

1. Wait until helium stops evaporating and the quench valves are closed.
2. Wait until there is no helium vapor visible anywhere to make sure there is sufficient oxygen in the room.
3. Switch off the alarm at the CMU.
4. Check that the globes in the quench valves are in the correct position.
5. Remove probe and shim system to prevent icing of the shim system.
6. Start the refill with liquid helium as soon as possible.



If the quench occurs unattended or helium transfer was not possible within one hour after the quench, it is recommended to warm up the system to 90 K. Refer to the supplied manual Refilling Procedure.

7. Contact Bruker Service immediately.

## 6.3.2 Procedure in case of an alarm signal

---

If the temperature of the radiation shield, the heater power or pressure inside the helium vessel exceeds the set maximum allowed values, an alarm will warn the operator (audible from the CMU, visible at the display of the CMU and the console via MICS).

Follow this procedure to fix the issue before contacting Bruker Service.

Take notes of:

- Date and time.
- Temperature given on the display of MICS.
- Turn off the alarm of the CMU.
- Which errors or warnings appear?
- What are the readings of the pressure gauges, run time counter etc. of the compressor?
- Which parts seem to be ok/not ok?
- How did the failure occur and what happened before failure?

## 6.3.3 Procedure in case of Cryogenic Refrigerator failure

---

### **SAFETY INSTRUCTIONS**

In case of a failure of the Cryogenic Refrigerator the temperature of the shield ( $T_{RS}$ ) will rise to 135 K and the helium will boil off at 1000 ml/h.

The maximum outage time is 7 days.

- Call Bruker Service.
- Restart the Cryogenic Refrigerator and refill Helium to maximum level. See chapter “**During Operation of the Cryogenic Refrigerator**” on page 71 for further information.
- If the Cryogenic Refrigerator cannot be restarted, the magnet must be deenergized immediately.

### **SAFETY INSTRUCTIONS**

If restarting the Cryogenic Refrigerator was successful, it will take at least two days to recover the previous state of the magnet system.

- If the temperature and helium boil off does not decrease within two following days call Bruker Service.

# 7 Maintenance

Maintenance must be performed only with approved qualification.

In case of doubt contact Bruker Service. For contact information [see page 7](#) of this document.

## 7.1 Safety

---

### Approved Persons

Bruker Service, Approved Customer Personnel

### WARNING



**Magnetic Fields (see [page 18](#))**

**Cryogenic Agents (see [page 19](#))**

**Electricity (see [page 20](#))**

**Gas under Pressure (see [page 21](#))**

**Low Temperatures (see [page 19](#))**

**Spontaneous Ignition and Explosion (see [page 21](#))**

**Hot Surfaces (see [page 23](#))**

### Personal protective equipment

Protective goggles

Protective gloves

Safety shoes

## 7.2 Cleaning

---

### Procedure

- Clean the RT vessel of the magnet system and the magnet stand with a dry or slightly damp cloth.
- Only use water and neutral detergents.
- Do not use volatile cleaning solvents.

## 7.3 Maintenance Timetable

---

Interval	Device	Work	By
daily	Cryostat	Check the helium flow.	Approved Customer Personnel
4.500 h (0.5 year)	Cryogenic Refrigerator	<ul style="list-style-type: none"> <li>• Check the values at the high and low pressure gauges on the front panel of the compressor if the mean values are different and if an oscillation of the needles is noticeable. Refer to the supplied manual of the Cryogenic Refrigerator. Contact Bruker Service if values are different.</li> <li>• Check the proper operation of the water cooling unit.</li> <li>• Check system pressure, water flow and temperatures. Refer to the manual of the water cooling unit for further information.</li> </ul>	Approved Customer Personnel

Table 7.1: Maintenance Timetable - part 1

Table continued



Continued from the previous page

Interval	Device	Work	By
17.500 hours (2 years)	Cryogenic Refrigerator	<ul style="list-style-type: none"> <li>• Replace the rotary valve. Refer to chapter "Replacement of the Rotary Valve and the Cold Head" in the Service Manual.</li> <li>• Replace the adsorber of the compressor. Refer to the supplied manual of the Cryogenic Refrigerator.</li> <li>• Check the values at the high and low pressure gauges on the front panel of the compressor if the mean values are different and if an oscillation of the needles is noticeable. Refer to the supplied manual of the Cryogenic Refrigerator.               <ul style="list-style-type: none"> <li>- Pressure too high: Vent helium gas. Use the Service Kit.</li> <li>- Pressure too low: Refill helium gas of high purity (He 5.0, 99.999%). Use the Service Kit.</li> </ul> </li> </ul>	Bruker Service
35.000 hours (4 years)	Cryogenic Refrigerator	<ul style="list-style-type: none"> <li>• Replace rotary valve and cold head. Refer to chapter "Replacement of the Rotary Valve and the Cold Head" in the Service Manual.</li> <li>• Replace the compressor.</li> </ul>	Bruker Service

Table 7.2: Maintenance Timetable - part 2

## 7.4 Maintenance Work at the Cryogenic Refrigerator

---

Approved Persons: Bruker Service only

# 8 Disassembling

## 8.1 Safety

---

Approved Persons: Bruker Service only



# 9 Technical Data MS 600'54 Ascend Aeon RZ

## 9.1 Environmental Conditions

---

	Value	Unit
Minimum surrounding temperature	7	°C
Maximum surrounding temperature	38	°C
Maximum relative humidity up to 31 °C	80	%
Maximum relative humidity between 31 °C and 40 °C linearly decreasing	80 – 50	%

Table 9.1: Environmental conditions

## 9.2 Identification Plate

---

The identification plate is on the right rear side attached to the bottom plate of the cryostat.

### Contents of the identification plate:

- Address of the Manufacturer
- Magnet System Identifier
- Type
- Identification Number
- Magnet Identifier
- Serial Number
- Year of Construction
- Cryostat Identifier
- Specification Helium Vessel
- Specification Vacuum Chamber
- Weight (empty and completely filled) including magnet stand

## 9.3 Dimensions

---

### 9.3.1 Weights

---

	Value	Unit
Weight magnet system (empty, without magnet stand, without compressor package)	870	kg
Weight magnet system (completely filled, without magnet stand, without compressor package)	917	kg
Operational weight (completely filled, with magnet stand)	1094	kg
Weight magnet stand	177	kg
Weight magnet stand (ready for transportation, including box)	264	kg
Weight magnet system (empty, ready for transportation, including box and transportation locks)	1050	kg

Table 9.2: Weight of the magnet system

### 9.3.2 Dimensions for Transportation

---

	L x D x H	Unit
Box with magnet system	127 x 107 x 178	cm <sup>3</sup>
Box with magnet stand	134 x 74 x 131	cm <sup>3</sup>

Table 9.3: Dimensions for transportation of the magnet system

9.3.3 Dimensions Cryostat

Front View

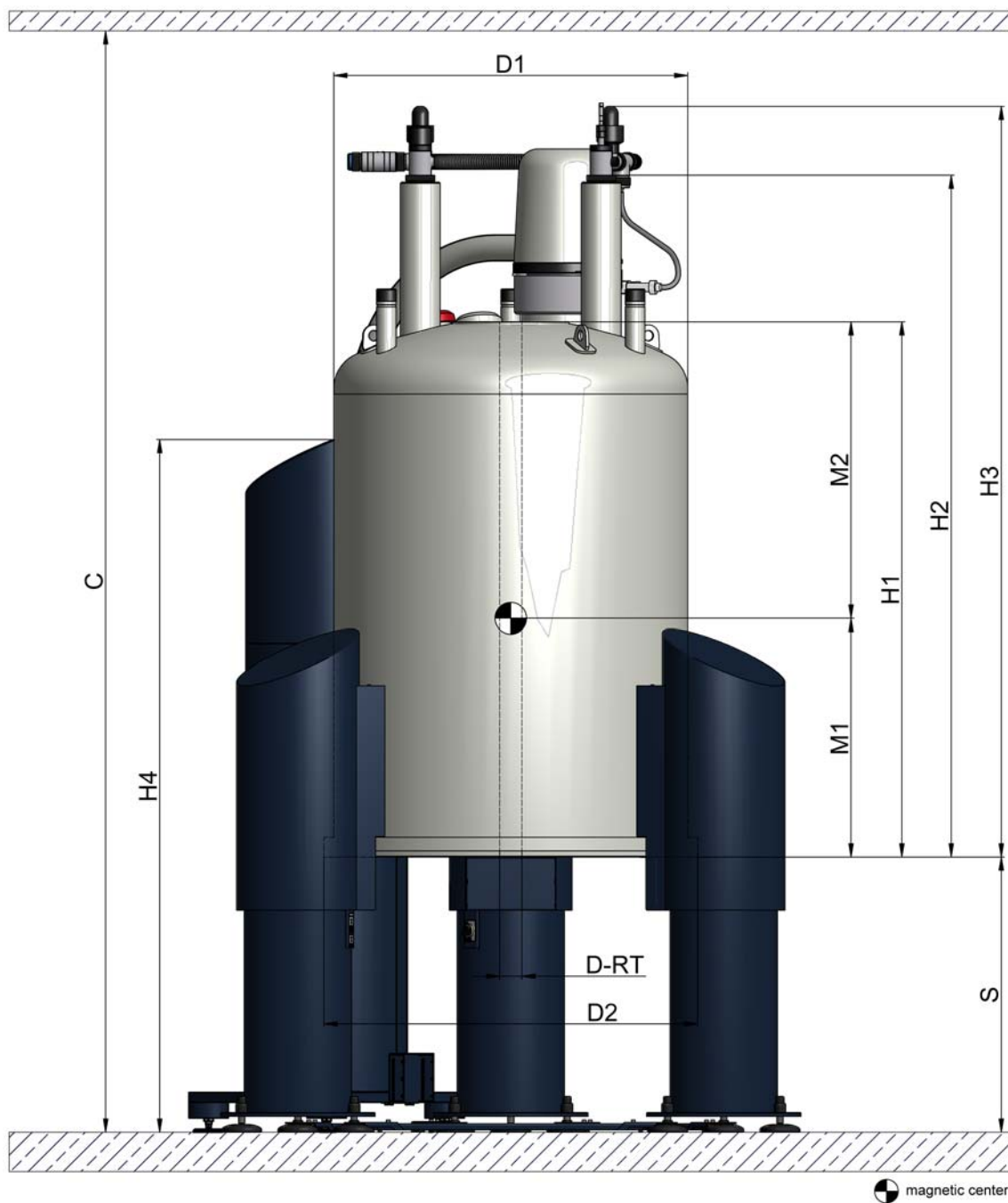

Figure 9.1: Dimensions of the cryostat (front view)

Dimensions Cryostat	Value	Unit
C Operational Ceiling Height	3000	mm
D-RT Diameter RT Bore Tube	54	mm
D1 Diameter RT vessel	900	mm
D2 Diameter Bottom Plate	950	mm
H1 Height Cryostat (bottom plate to top flange)	1360	mm
H2 Height Cryostat (minimum height for transportation)	1750	mm
H3 Height Cryostat (bottom plate to flow system)	1908	mm
S Height Magnet Stand (floor to bottom plate)	700	mm
M1 Distance magnetic center to bottom flange (calculated) Refer to <a href="#">Table 9.16 on page 108</a> for the measured distance of the magnetic center to bottom flange (MCB).	~416	mm
M2 Distance magnetic center to top flange (calculated) Refer to <a href="#">Table 9.16 on page 108</a> for the measured distance of the magnetic center to top flange (MCT).	~944	mm

Table 9.4: Dimensions of the cryostat – front view



**Top View**

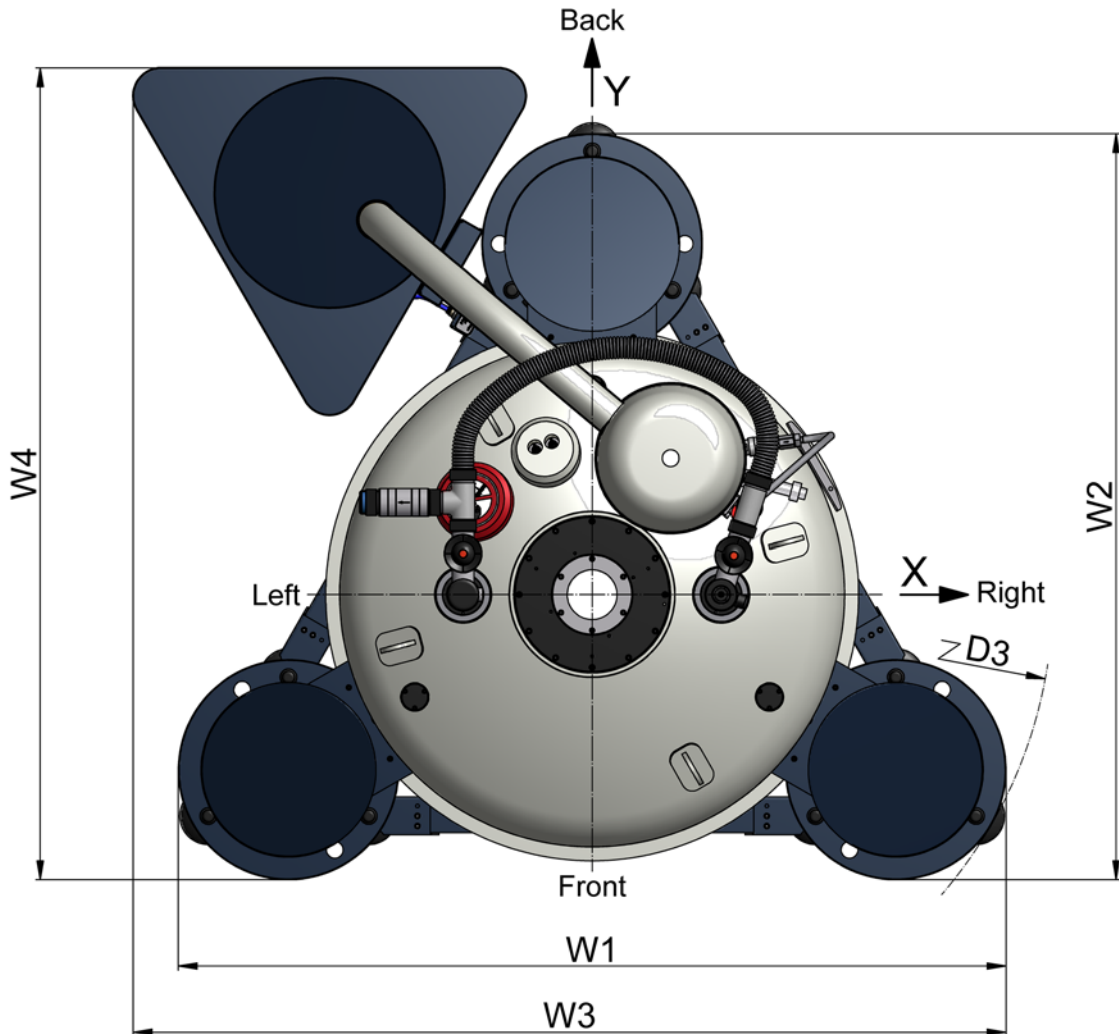

Figure 9.2: Dimensions of the cryostat (top view)

Dimensions Cryostat	Value	Unit
W1 (Width side to side)	1477	mm
W2 (Width front to back)	1340	mm
W3 (Width side to side including Rotary Valve Column)	1556	mm
W4 (Width front to back including Rotary Valve Column)	1448	mm
D3 <sup>1</sup> (Diameter magnet stand)	1661	mm

Table 9.5: Dimensions of the cryostat – top view

1. Keep at least an additional free space of 1.5 m around the magnet system for service.

## 9.4 Filling Volume, Evaporation Rate and Hold Time

### Consumption during installation

The consumption of liquid cryogenic agents during installation consists of consumption for cooling down the cryostat, for energizing, cryo shimming and quench reserve.

Cryogenic Agents Consumption	Value	Unit
Nitrogen	800	l
Helium (needed for cooling down)	500	l
Helium (needed for energizing, cryo shimming and quench reserve)	500	l

Table 9.6: Cryogenic Agents Consumption during Installation

Cryogenic Agents	Value	Unit
Helium vessel total volume	376	l
Helium refilling volume	48	l
Helium evaporation rate (if Cryogenic Refrigerator is not operating)	1000	ml/h
Maximum helium hold time (= maximum time interval between helium refillings) with Cryogenic Refrigerator operating	3000	days
Helium hold time during unexpected break down of cooling system when helium level is at 100 %	> 10	days
Helium hold time during unexpected break down of cooling system when helium level did reach minimum allowed level	> 7	days
Helium refilling volume after quench (cool down and refill)	500	l

Table 9.7: Cryogenic Agents

9.5 Helium Level Graph

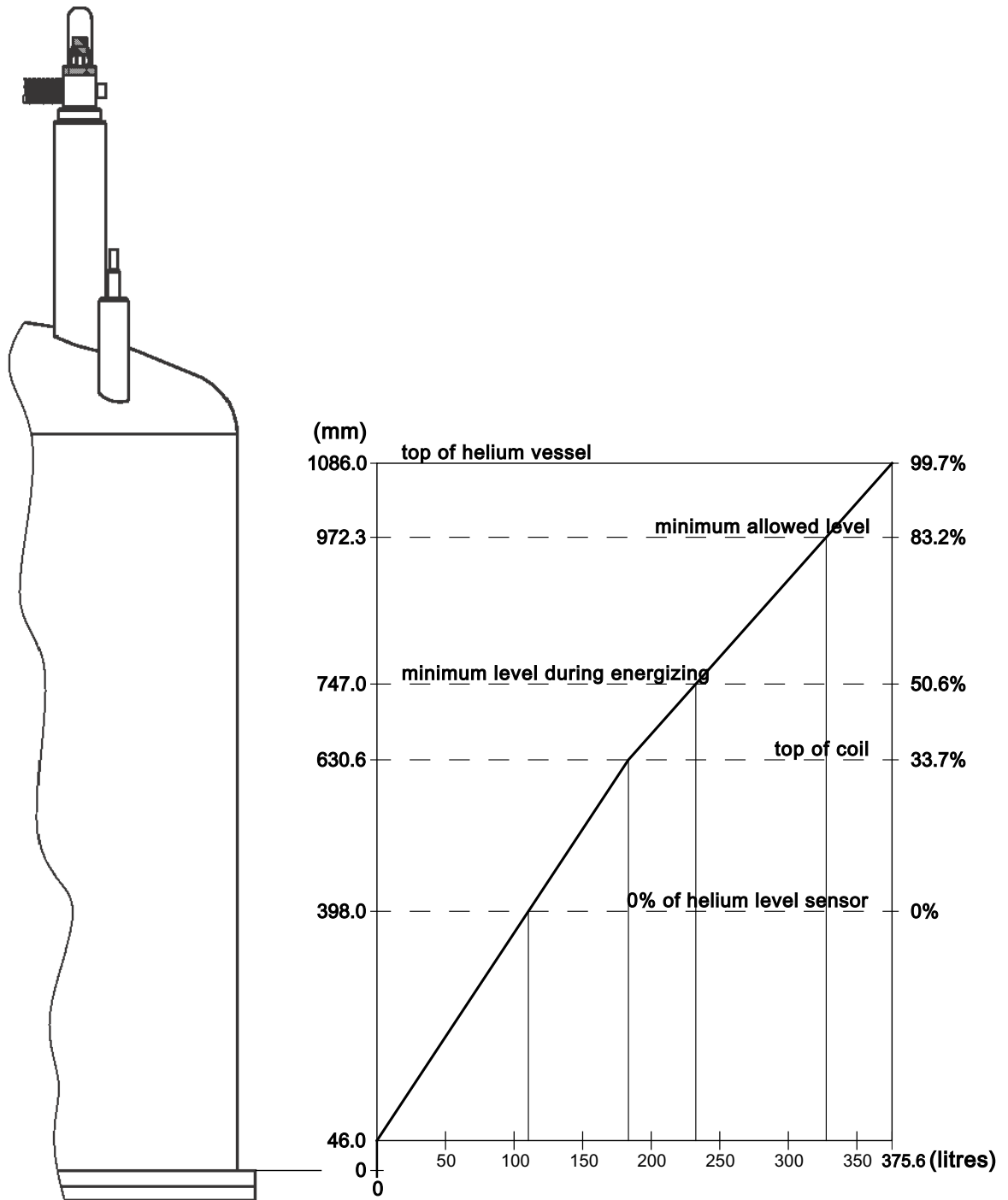

Figure 9.3: Helium Level Graph

## 9.6 Helium Level Sensor

The Helium Level Sensor is inserted in the helium fill-in turret.

Helium Level Sensor	Material No.	Value	Unit
Level Sensor Type	Z58114	1300/690	
Overall length		1300	mm
Active length		690	mm
Calibration 0 %, Calibration resistor	Z28630 blue	140	$\Omega$
Calibration 100 %, Calibration resistor	Z28628 black	15	$\Omega$

Table 9.8: Helium Level Sensor

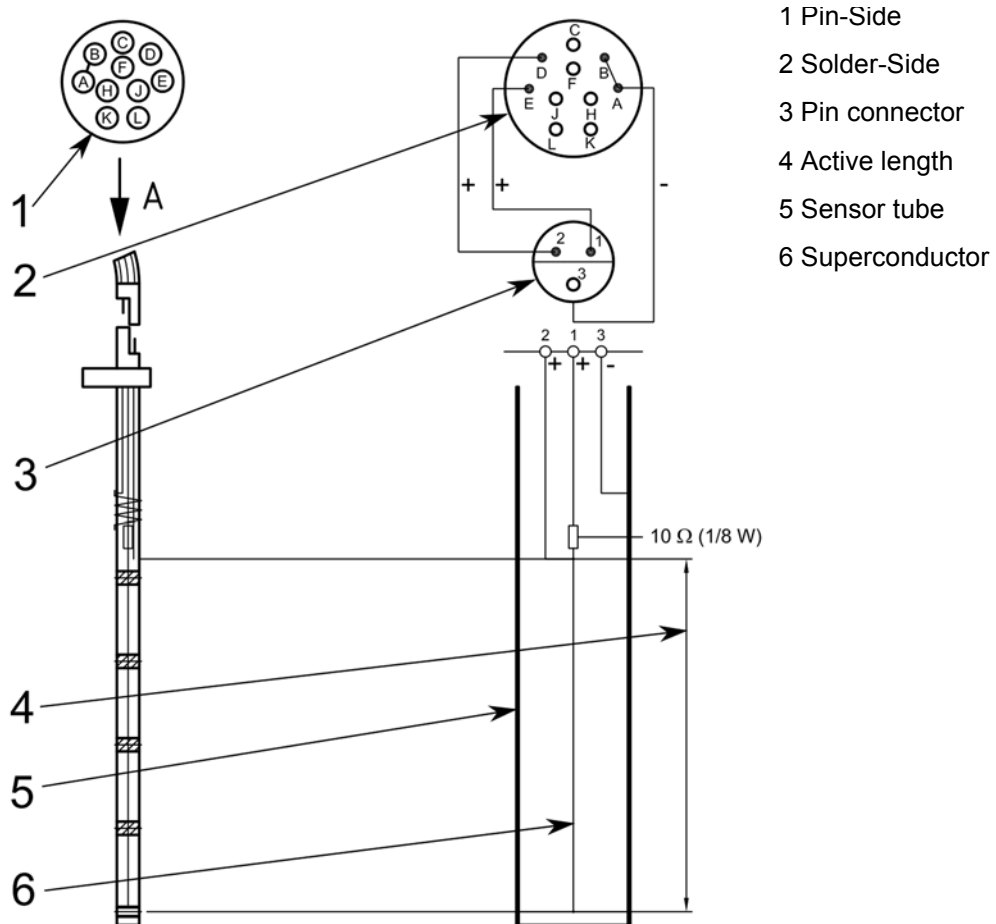

Figure 9.4: Helium Level Sensor

## 9.7 Temperature Sensors

The temperature sensors (PT 100 and IBT) are used to monitor the temperature of the magnet during cooling down and warming up the magnet system.

### PT 100 Sensor



Measure the resistance with a maximum current of 1 mA.

	Temperature	Unit	Resistance	Unit
Room Temperature	293	K	107.8	Ω
	273	K	100.0	Ω
	250	K	91.0	Ω
	200	K	71.1	Ω
	150	K	50.9	Ω
	100	K	30.0	Ω
Liquid Nitrogen	77	K	20.1	Ω

Table 9.9: Characteristic Values of PT 100 Sensor

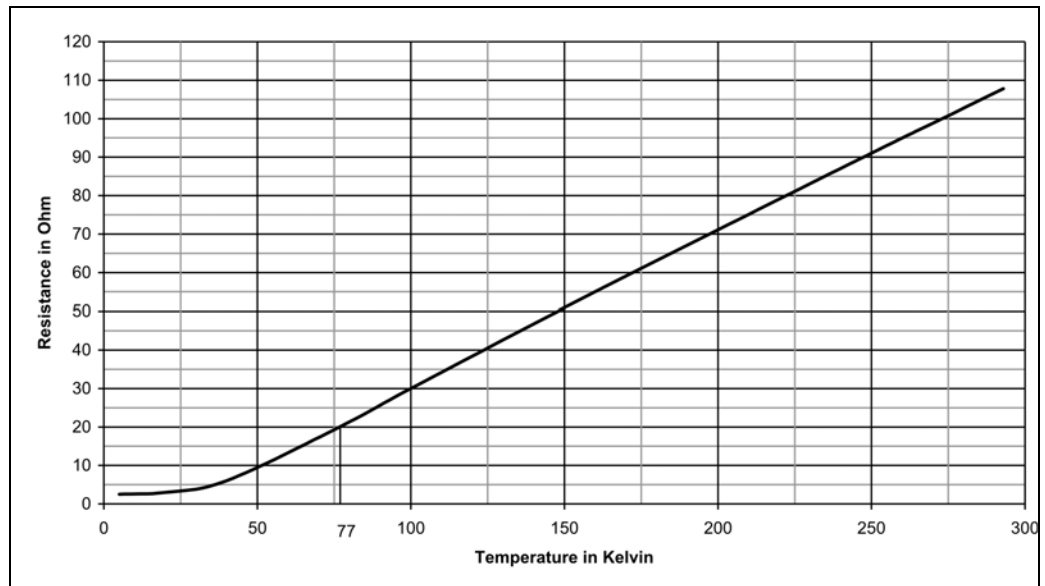

Figure 9.5: Characteristic Curve of PT 100 Sensor

## IBT Carbon Resistor



Measure the resistance with a maximum current of 0.1 mA.

	Temperature	Unit	Resistance	Unit
Room Temperature	300	K	220	$\Omega$
Liquid Nitrogen	77	K	265	$\Omega$
	40	K	300	$\Omega$
	20	K	350	$\Omega$
	10	K	420	$\Omega$
	8	K	450	$\Omega$
	6	K	500	$\Omega$
	5	K	540	$\Omega$
Liquid Helium	4.2	K	575	$\Omega$

Table 9.10: Characteristic Values of IBT Carbon Sensor

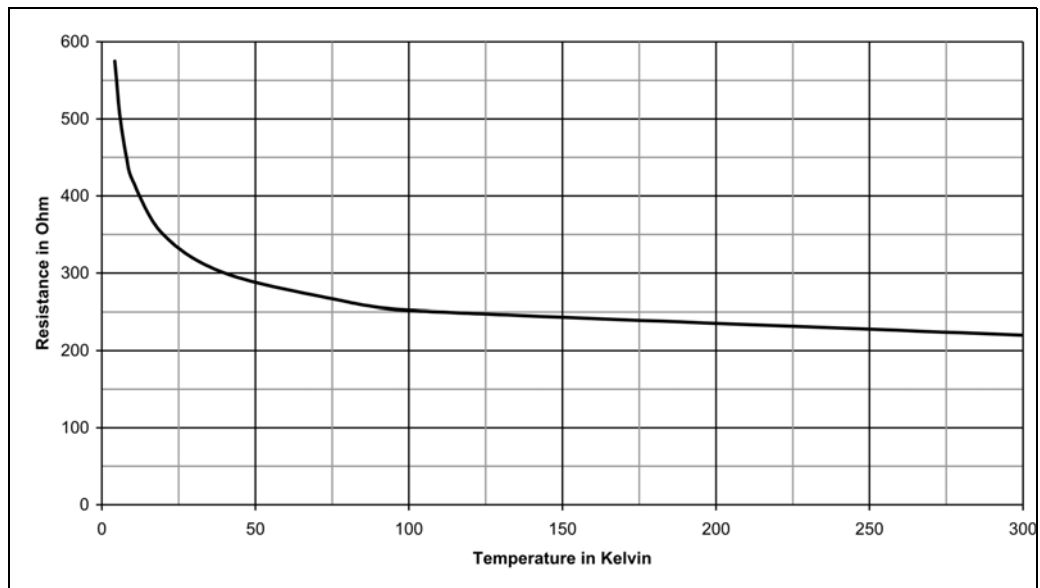

Figure 9.6: Characteristic Curve of IBT Carbon Sensors

**Wiring Diagram Temperature Sensors**

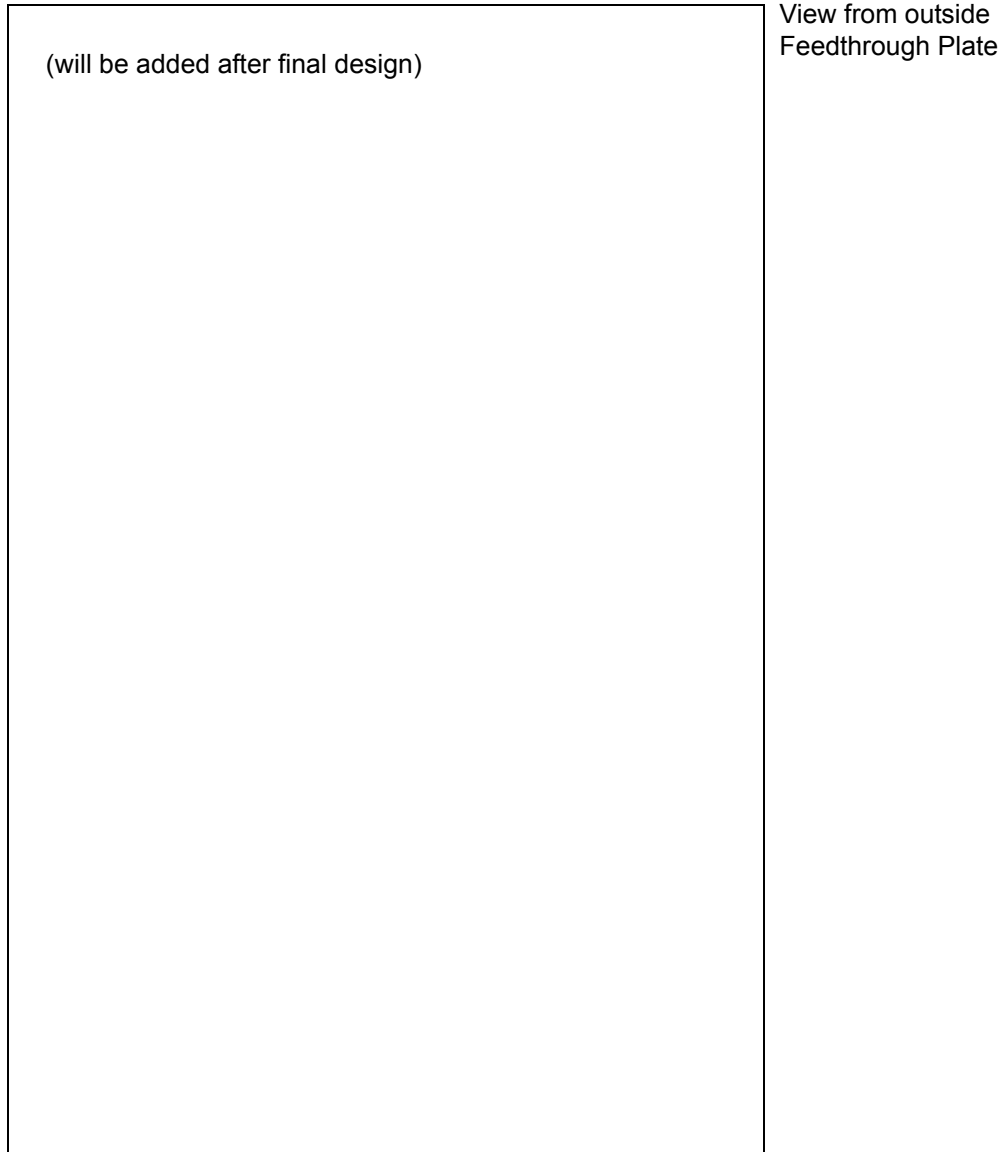

Figure 9.7: Wiring Diagram Temperature Sensor

## 9.8 Technical Data Magnet

Technical Data Magnet	Value	Unit
Proton frequency	600	MHz
Central field	14.09	T
Coil inductance	46	H
Magnetic energy	774	kJ
Maximum drift rate	0.01	ppm/h
	6	Hz/h

Table 9.11: Specification of the Magnet

### Operating Modes of the Magnet System:

#### Driven Mode

In the driven mode the current lead is mounted and the electricity is flowing through the power supply. The coils of the magnet can be energized and deenergized.

#### Persistent Mode

In the persistent mode the electricity is flowing exclusively within the magnet. The circuit has no connection to the outside. The magnetic field cannot be switched off.



## 9.9 Fringe Field Plot

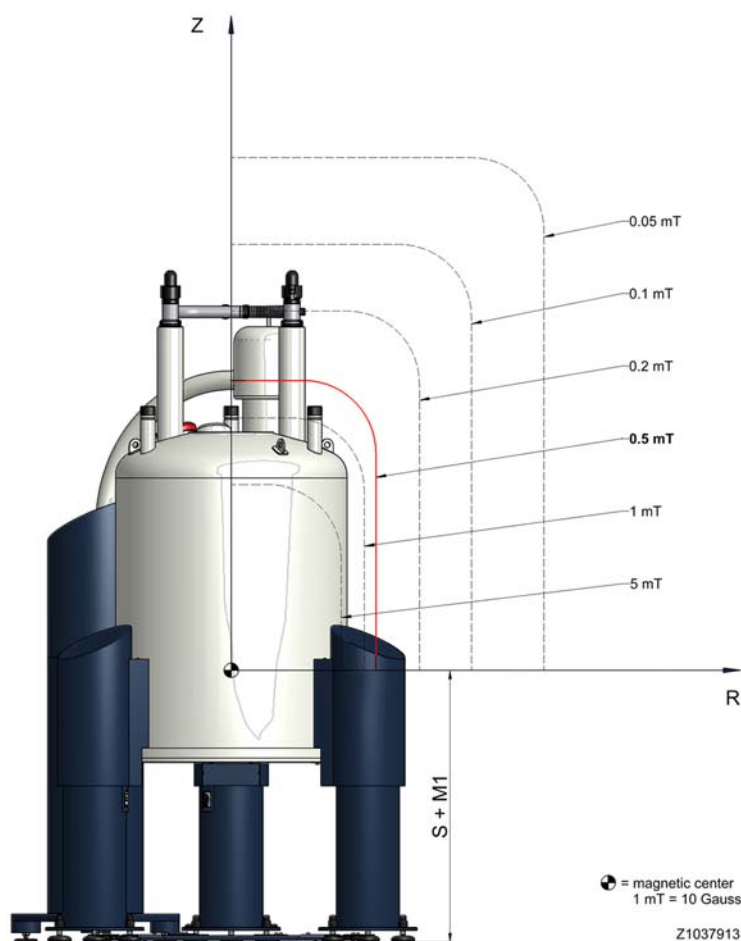

Figure 9.8: Fringe field plot of the magnet system at maximum field

Fringe Field	Unit	R max	Unit	Z max	Unit
200	mT	0.29	m	0.48	m
5.0	mT	0.50	m	0.88	m
3.0	mT	0.54	m	0.97	m
1.0	mT	0.62	m	1.21	m
<b>0.5 (5 Gauss)</b>	<b>mT</b>	<b>0.70</b>	<b>m</b>	<b>1.40</b>	<b>m</b>
0.2	mT	0.92	m	1.73	m
0.1	mT	1.17	m	2.07	m
0.05	mT	1.52	m	2.49	m
max. magnetic field B0 at access point				306	mT
max. field gradient dB/dz at access point				4.6	T/m

Table 9.12: Fringe field data of the magnet system at maximum field

## 9.10 Technical Data Cryogenic Refrigerator

### PT405 RM with CP2850

For more information on the cold head and the compressor refer to the manual on CD-ROM, included in the compressor shipping box.

<b>Compressor CP2850 Water Cooled 420 VAC 50/60 Hz</b>	
Nominal voltage	380/415 VAC (50 Hz)
	440/480 VAC (60 Hz)
Operating voltage	342 – 456 VAC (50 Hz)
	396 – 528 VAC (60 Hz)
Frequency	50 – 60 Hz
Phase	3
Maximum input power	5.8 kW (50 Hz)
	5.5 kW (60 Hz)
Steady state power consumption	4.6 kW (50 Hz)
	5.2 kW (60 Hz)
Current	10 A (50 Hz)
	8.5 A (60 Hz)
Dedicated circuit breaker	25 A

<b>Compressor CP2850 Water Cooled 230 VAC 50/60 Hz</b>	
Nominal voltage	200 VAC (50 Hz)
	200/230 VAC (60 Hz)
Operating voltage	180 – 220 VAC (50 Hz)
	180 – 253 VAC (60 Hz)
Frequency	50 – 60 Hz
Phase	3
Maximum input power	6.6 kW (50 – 60 Hz)
Steady state power consumption	5.0 kW (50 – 60 Hz)
Current	22 A (50 – 60 Hz)
Dedicated circuit breaker	40 A

<b>Helium Static Pressure all components @ 25 °C (77 °F)</b>	
60 Hz System	15.2 ± 0.34 bar (220 ± 5 PSIG)
50 Hz System	17.2 ± 0.34 bar (250 ± 5 PSIG)

Table 9.13: Helium Static Pressure

<b>Cooling Water Requirements</b>	<b>Value</b>
Alkalinity	5.8 < pH < 8.0
Calcium Carbonate	Concentration < 80 PPM
Maximum Inlet Pressure	7.6 bar      110 PSIG
Cooling Water minimum flow @ maximum temperature	~ 8.5 l/min @ temp. ≤ 26 °C ~ 5.5 l/min @ temp. 20 °C ~ 3.5 l/min @ temp. 12 °C

Table 9.14: Cooling Water Requirements

9.11 Current Lead

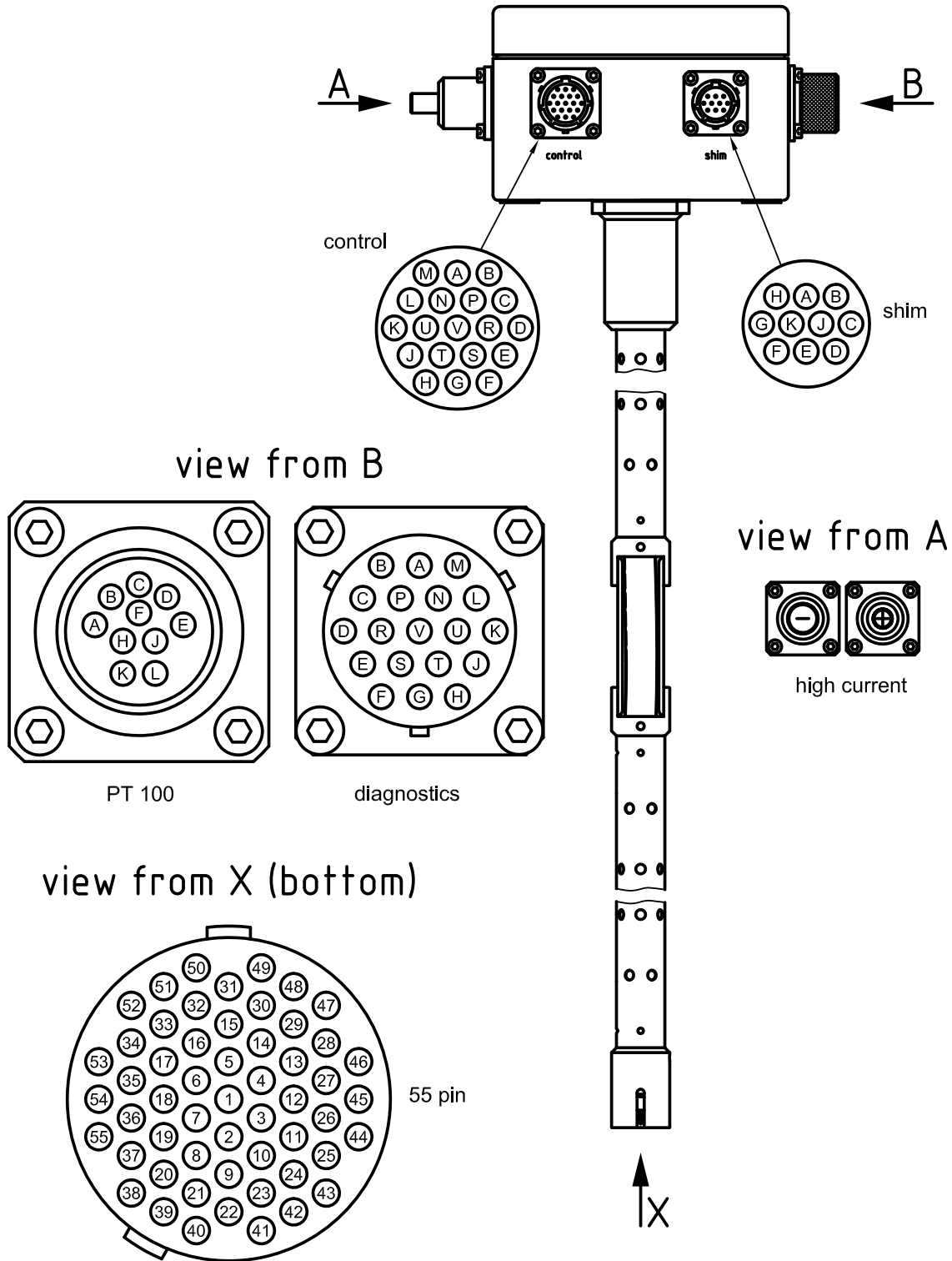

Z1029367

Figure 9.9: Current Lead 55 pins

## 9.11.1 Wiring Diagram Magnet

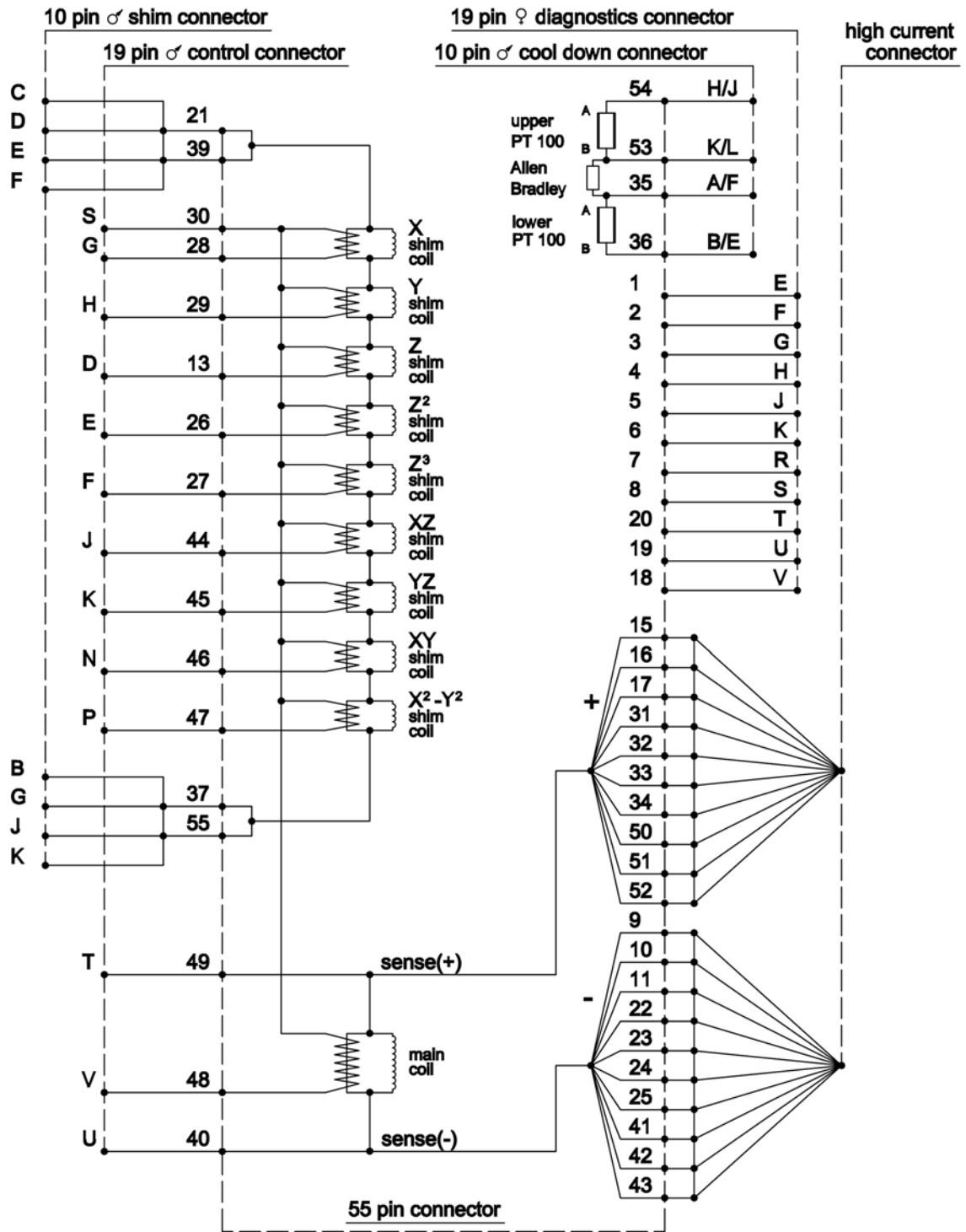

Z1030082

Figure 9.10: Wiring Diagram Magnet

## 9.11.2 Wiring Diagram Magnet Control

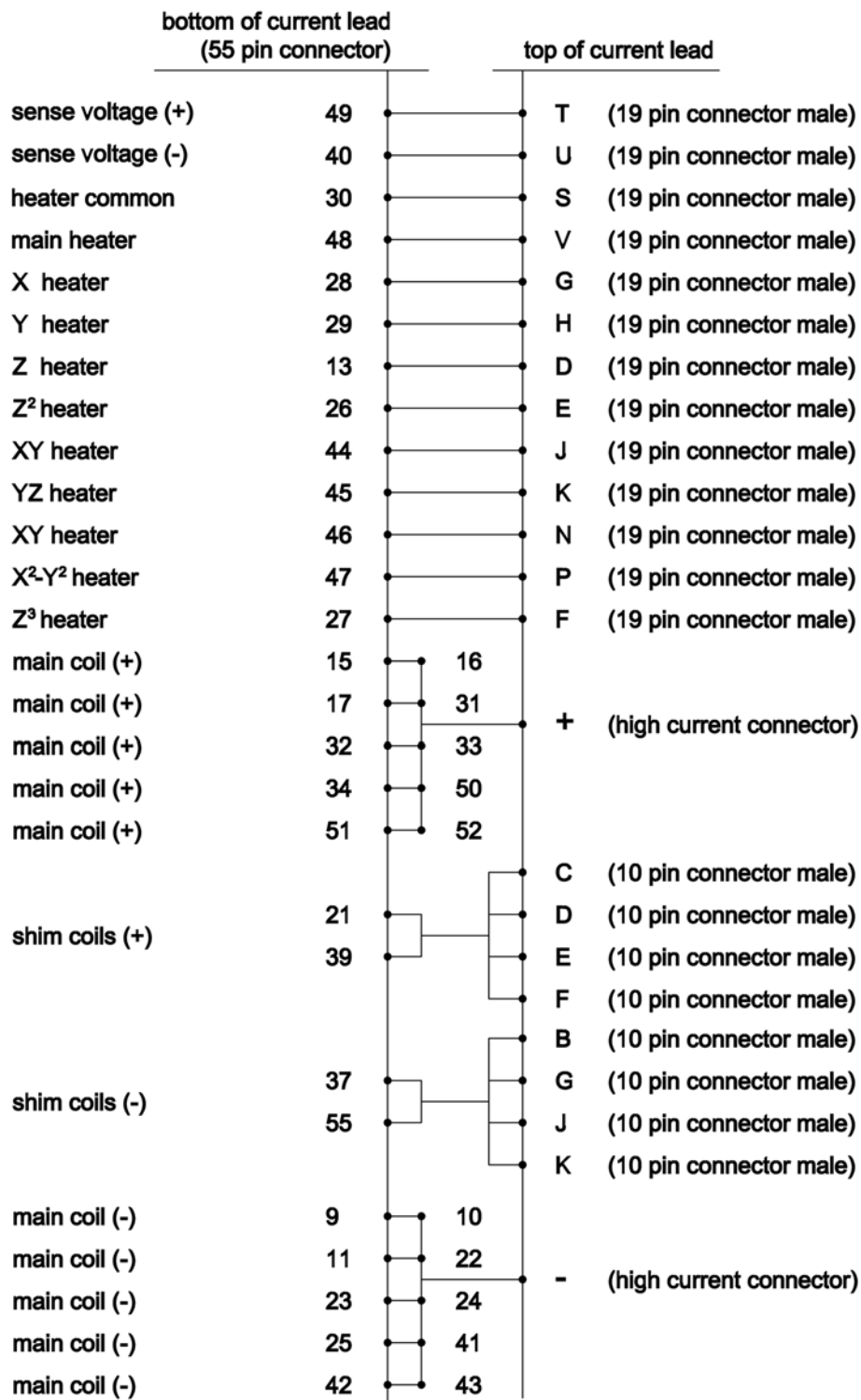

Z1029391

Figure 9.11: Wiring Diagram Magnet Control

## 9.11.3 Wiring Diagram Magnet Diagnostic and Temperature Sensors

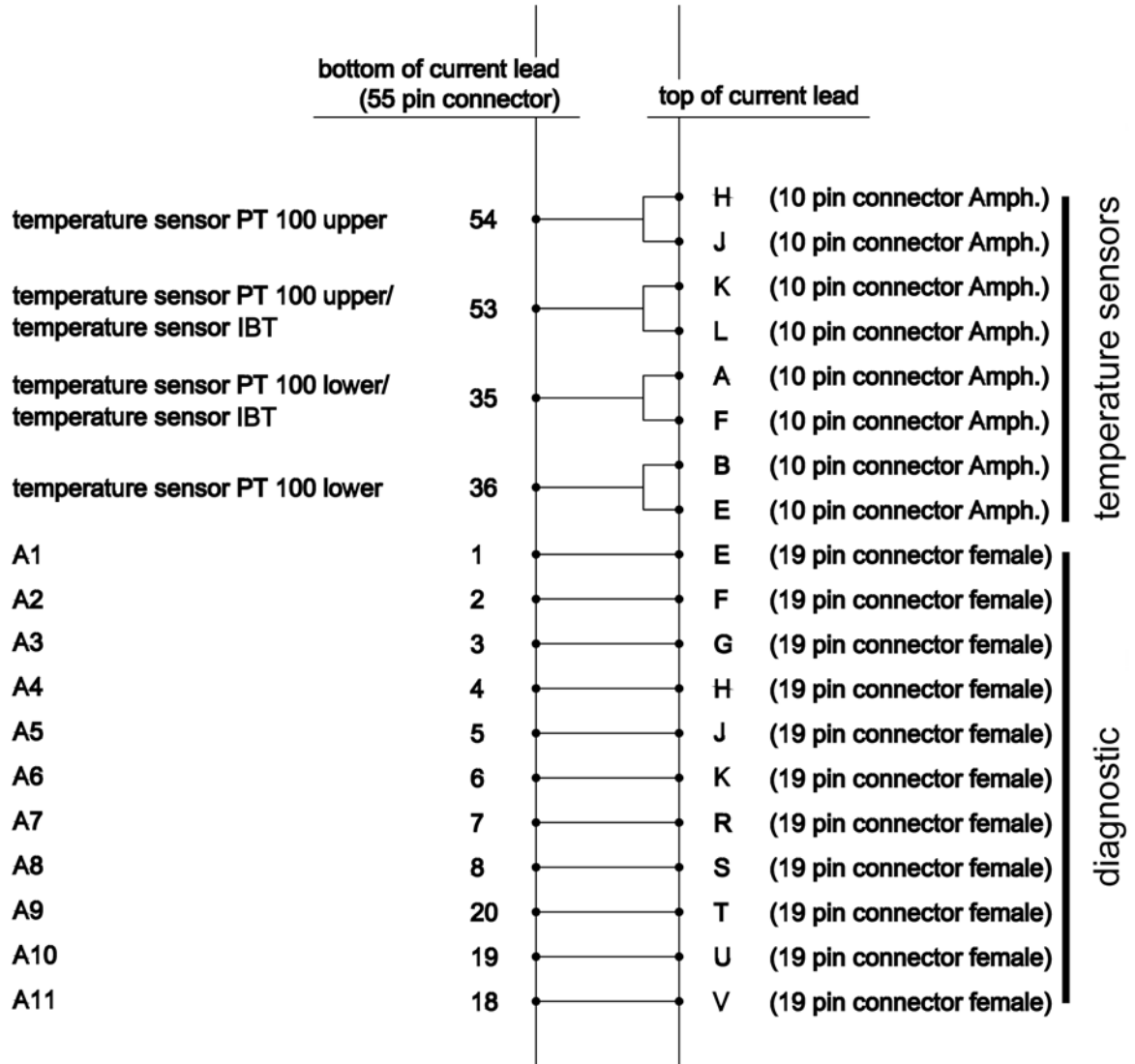

Z1029392

Figure 9.12: Wiring Diagram Magnet Diagnostic and Temperature Sensors

## 9.11.4 Shorting Plug

The shorting plug is plugged after removal of the current lead. After inserting the shorting plug the current flows through the shorting plug and no longer through the current lead and the power supply.

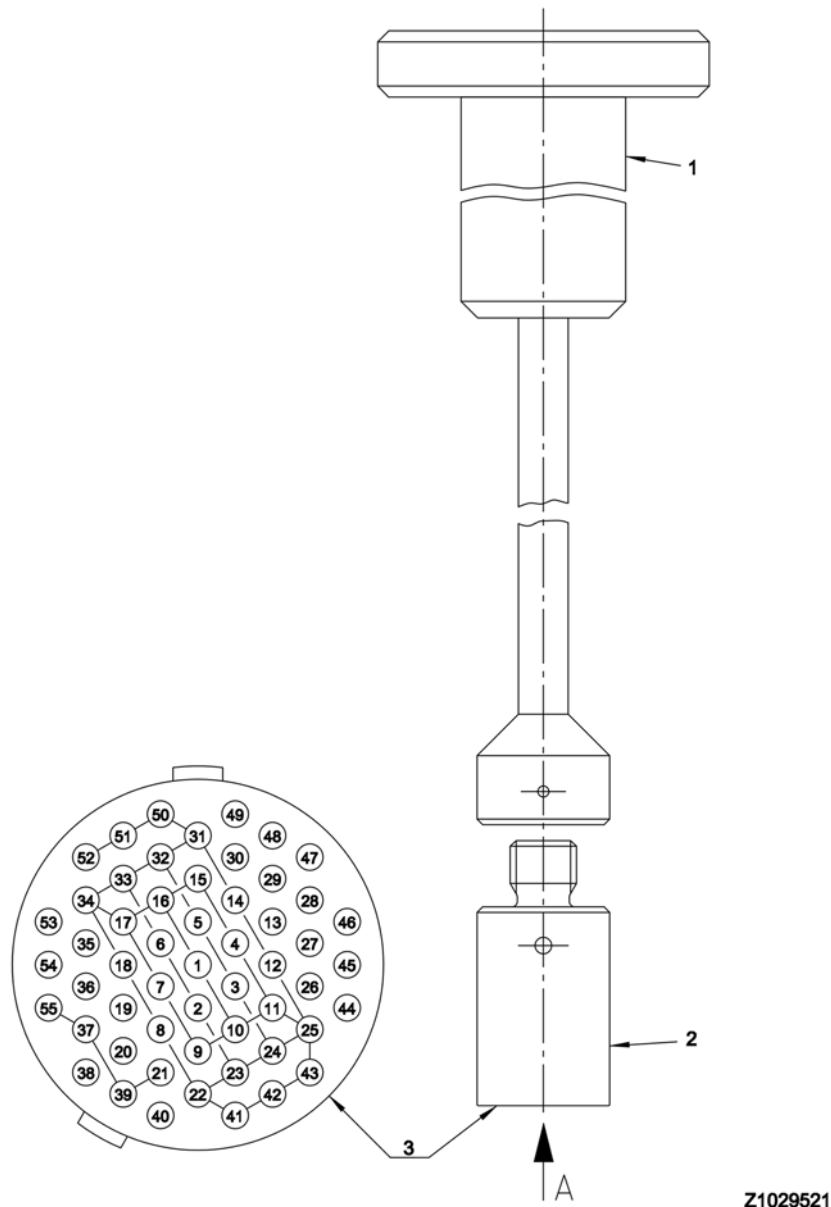

Figure 9.13: High Current Shorting Plug

- 1 Shorting Plug Tool for fitting and removing the shorting plug
- 2 Shorting Plug
- 3 Shorting Plug – view from pin side



## 9.12 Resistance at Room Temperature

Current lead used to energize magnet:

○ Current Lead, 55 Pin 200 A <b>(grey)</b>	○ High Current Lead and High Current Diagnostic Lead, 55 Pin, 300 A <b>(blue)</b>	○ HTS Current Lead, 55 Pin 300 A <b>(green)</b>
--	---	---

	Pin	Connector	Description	Value	Unit
From:	PIN V	19 PIN Con CONTROL	Main Heater		Ω
To:	PIN S	19 PIN Con CONTROL			
From:	PIN D	19 PIN Con CONTROL	Z Heater		Ω
To:	PIN S	19 PIN Con CONTROL			
From:	PIN G	19 PIN Con CONTROL	X Heater		Ω
To:	PIN S	19 PIN Con CONTROL			
From:	PIN H	19 PIN Con CONTROL	Y Heater		Ω
To:	PIN S	19 PIN Con CONTROL			
From:	PIN J	19 PIN Con CONTROL	XZ Heater		Ω
To:	PIN S	19 PIN Con CONTROL			
From:	PIN K	19 PIN Con CONTROL	YZ Heater		Ω
To:	PIN S	19 PIN Con CONTROL			
From:	PIN N	19 PIN Con CONTROL	XY Heater		Ω
To:	PIN S	19 PIN Con CONTROL			
From:	PIN P	19 PIN Con CONTROL	X <sup>2</sup> -Y <sup>2</sup> Heater		Ω
To:	PIN S	19 PIN Con CONTROL			
From:	PIN E	19 PIN Con CONTROL	Z <sup>2</sup> Heater		Ω
To:	PIN S	19 PIN Con CONTROL			
From:	PIN C,D,E,F	10 PIN Con SHIM	Shim Coils +/-		Ω
To:	PIN B,G,J,K	10 PIN Con SHIM			
From:	PIN C	10 PIN Con SHIM	Shim Coil to		Ω
To:	PIN S	19 PIN Con CONTROL	Heater (common)		
From:	+	High current Con	High Current to		Ω
To:	PIN T	19 PIN Con CONTROL	Sense +		
From:	+	High current Con	Main Coil		Ω
To:	-	High current Con			
From:	-	High current Con	High Current to		Ω
To:	PIN U	19 PIN Con CONTROL	Sense -		
From:	PIN F	19 PIN Con CONTROL	Z <sup>3</sup> Heater		Ω
To:	PIN S	19 PIN Con CONTROL			
From:	PIN T	19 PIN Con CONTROL	Sense +		Ω
To:	PIN U	19 PIN Con CONTROL	Sense -		
From:	PIN C	10 PIN Con SHIM	Shim Coil to		Ω
To:	PIN T	19 PIN Con CONTROL	Main Coil		
From:	PIN T	19 PIN Con CONTROL	Sense to		Ω
To:	PIN S	19 PIN Con CONTROL	Heater (common)		
From:	PIN K	10 PIN cool down Con	Upper temperature		Ω
To:	PIN H	10 PIN cool down Con	sensor PT 100		
From:	PIN A	10 PIN cool down Con	IBT Carbon		Ω
To:	PIN K	10 PIN cool down Con	temperature sensor		
From:	PIN A	10 PIN cool down Con	Lower temperature		Ω
To:	PIN B	10 PIN cool down Con	sensor PT100		
From:		All Connectors	Insulation Magnet to		Ω
To:		Ground	Cryostat		

Table 9.15: Resistance at Room Temperature

This page will be replaced by specific technical data.

## 9.13 Heater Currents

Heater Currents	Value	Unit
Main heater current		mA
Shim heater current		mA

Table 9.16: Heater currents

## 9.14 Shim Switch Heater

Heater operation during energizing / deenergizing

Shim Switch	Heater Operation
Z0	.....
Z <sup>1</sup>	automatic
Z <sup>2</sup>	permanent
Z <sup>3</sup>	automatic
X	automatic
Y	automatic
XZ	automatic
YZ	automatic
XY	automatic
X <sup>2</sup> -Y <sup>2</sup>	automatic

Table 9.17: Shim Switch Heater Operation

This page will be replaced by specific technical data.

### 9.15 Energizing Assignment and Currents

Check the “minimum level during energizing” (see ["Helium Level Graph" on page 91](#)).

Energizing Currents [A]			Sense Voltage [mV]	Remarks Bruker Test Site
	to			
	to			
	to			
	to			
<b>Overshoot ( % of final current)</b>				
	to	Overshoot		
<b>10 minutes break at overshoot current</b>				
Overshoot	to	Final current		
<b>Total energizing time [min] . . . . .</b>				
<b>Rate of current ramp-down with magnet in persistent mode [A/min] . . . . .</b>				
<b>Mandatory wait time between energizing and shimming</b>				

Table 9.18: Energizing assignment and currents

9.16 Magnetic Center

Magnetic Center	Value	Unit
Distance magnetic center from top flange (MCT)		mm
Distance magnetic center from bottom flange (MCB)		mm
Shimsystem Offset (SO)		mm
see Figure 9.14: and refer to the supplied Test Protocol AST		

Table 9.19: Magnetic center

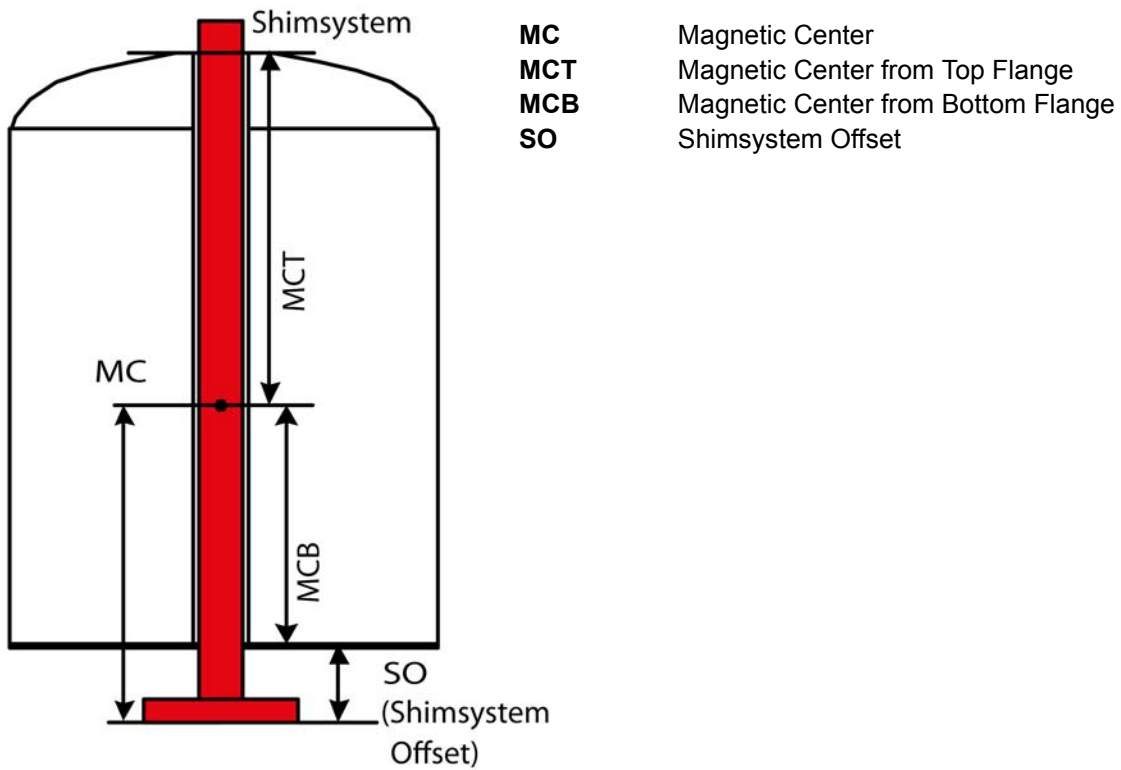

Figure 9.14: Magnetic center and shimsystem offset (SO)

This page will be replaced by specific technical data.

### 9.17 Cycling Assignment and Shim Currents

Cycling is recommended only for magnet systems at 500 MHz and more.

Shim Currents	Value	Unit
Time between energizing and cycling		h
Shim current rate		A/min
Z <sup>1</sup> Shim current		A
Z <sup>2</sup> Shim current		A
Z <sup>3</sup> Shim current		A
X Shim current		A
Y Shim current		A
XZ Shim current		A
YZ Shim current		A
XY Shim current		A
X <sup>2</sup> -Y <sup>2</sup> Shim current		A
Frequency change due to cycling		kHz
Date and Signature		

Table 9.20: Cycling assignment and shim currents

## 9.18 Energizing Currents

Energizing Currents	Value at Customer Site #1	Value at Customer Site #2	Value at Customer Site #3	Value at Customer Site #4	Unit
Magnet main current					A
Z <sup>1</sup> Shim current					A
Z <sup>2</sup> Shim current					A
Z <sup>3</sup> Shim current					A
X Shim current					A
Y Shim current					A
XZ Shim current					A
YZ Shim current					A
XY Shim current					A
X <sup>2</sup> -Y <sup>2</sup> Shim current					A
Shimsystem Offset design value	Refer to the supplied Test Protocol AST				mm
Shimsystem Offset Customer Site value					mm
Date and Signature					

Table 9.21: Energizing currents

## 9.19 Deenergizing Assignment and Currents

Deenergizing Currents [A]		Sense Voltage [mV]	Remarks Bruker Test Site
	to		
	to		
	to		
<b>Total deenergizing time [min]</b>			
	to		

Table 9.22: Deenergizing assignment and currents







# Appendix A

## A.1 Warning Signs

---

### Danger

Key Word and Symbol .....	15
---------------------------	----

### Warning

Cryogenic Agents .....	19
Electricity .....	20
Gas under Pressure .....	21
Heavy Weights .....	23
Intended Use .....	16
Key Word and Symbol .....	15
Low Temperatures .....	19
Magnetic Field .....	18
Persons .....	16
Quench .....	20
Risk of Slippage .....	22
Risk of Tilting .....	22
Safety Devices .....	17
Signs and Labels .....	18
Spare Parts .....	17
Spontaneous Ignition and Explosion .....	21

### Caution

Incorrect Transportation .....	24
Key Word and Symbol .....	15

### Notice

Key Word and Symbol .....	15
---------------------------	----

### Safety Instructions

Cryogenic Refrigerator Failure .....	78
Key Word and Symbol .....	15
Restarting the Cryogenic Refrigerator .....	78



## A.2 Figures

---

Figure 3.1:	Packaging (without surrounding panels).....	29
Figure 3.2:	Transportation by forklift - front side .....	31
Figure 3.3:	Transportation by forklift - rear side .....	31
Figure 3.4:	Attachment points for lifting equipment.....	32
Figure 3.5:	Instruction label for lifting equipment .....	32
Figure 5.1:	Start the Magnet Stand .....	38
Figure 5.2:	Stop the Magnet Stand .....	38
Figure 6.1:	Magnet system during a quench.....	76



### A.3 Tables

---

Table 7.1:	Maintenance Timetable - part 1 .....	80
Table 7.2:	Maintenance Timetable - part 2 .....	81
Table A.1:	Glossary .....	119
Table A.2:	Abbreviations .....	120



## A.4 Glossary / Abbreviations

---

Used term	Description
Cryostat	The collective of all parts providing a temperature of 4 K inside for the superconducting magnet. The cryostat also provides the safety devices and the access ports for the cryogenic agents and electricity. The superconducting magnet inside the cryostat is not energized.
Dewar	Any kind of package used for transporting cryogenic agents like liquid helium or nitrogen.
Pressure Cylinder	Any kind of package used for transporting gaseous agents with a pressure up to 200 bar.
Magnet System	The collective of all parts necessary for the intended use. The superconducting magnet inside the cryostat is energized.

Table A.1: Glossary

Abbreviations	Description
ACD	Automatic Cooling Device
BSMS	Bruker Smart Magnet Control System
BSVT	Bruker Smart Variable Temperature System
CCA	Compressor Control Adaptor
CMU	Cryostat Monitoring Unit
GUI	Graphical User Interface
JAC	Java Controller
MICS	Magnet Information and Control System
NMR	Nuclear Magnetic Resonance
RS	Radiation Shield
RT	Room Temperature; used as prefix of parts which are at room temperature
RV	Rotary Valve
RVC	Rotary Valve Column

Table A.2: Abbreviations



## A.5 Index

---

### A

Access Point .....	97
Attachment Point .....	32

### B

Bursting Disc .....	27
---------------------	----

### C

Complaint Process .....	30
Cryogenic Agents .....	18
Cryogenic Refrigerator .....	11
Cryogenic Refrigerator Cold Head ....	10
Cryogenic Refrigerator Compressor ..	10
Current Lead Turret .....	10

### D

Disturbances .....	48
Driven Mode .....	96
Drop-off Plate .....	27

### E

Electricity .....	20
Emergency .....	28

### F

First Aid for Cold Burns .....	28
Flex Lines .....	10
Fringe Field Plot .....	97

### H

Helium Flow System .....	10
Helium Level Graph .....	91
Helium Level Sensor .....	92
High Current Lead .....	100

### I

IBT Carbon Resistor .....	94
Identification Plate .....	85
Intended Use .....	16

### L

Liability .....	9
Low Temperatures .....	19

### M

Magnet Stand .....	10
Magnetic Center .....	108
Magnetic Field .....	18

### P

Persistent Mode .....	96
Portable Oxygen Monitor .....	25
Pressure Relief Valve .....	27
PT 100 Sensor .....	93

### Q

Quench .....	20, 76
Quench Valve .....	27

### R

Rescue Equipment .....	28
Rotary Valve .....	10
Rotary Valve Column .....	10
RT Bore .....	10
RT Vessel .....	10

### S

Safety Devices .....	27
Shimsystem Offset (SO) .....	108
Shock Watch .....	30
Spontaneous Ignition .....	21

### T

Technical Data .....	85
Technical Data Magnet .....	96
Tilt Watch .....	30
Tilting .....	22

### W

Warranty .....	9
Weights .....	86
Wiring Diagram Magnet .....	101



## Revision History List

<b>Index:</b>	<b>Date:</b>	<b>Alteration Type:</b>
00	January 2012	First release. Design of the magnet system not yet fixed.
01	September 2013	Update with new monitoring solution. New design front and rear page.
02	September 2015	Update of technical data; inserted shim system offset, shim switch heater operation and mandatory wait time after energizing. Added technical data of cryogenic refrigerator. Update of manual layout.
03	October 2015	New design of Helium flow system. Added opening pressure data of the safety devices of the magnet system.



**Bruker Corporation**

[info@bruker.com](mailto:info@bruker.com)  
[www.bruker.com](http://www.bruker.com)

Order No: Z31963